

Contenido

| | | | |
|------------------------|----|---------------------------------------|----|
| Color | 3 | Repasa el número y con | |
| Rojo | 3 | plumón..... | 51 |
| Círculo | 4 | Reposa cada número y pinta las | |
| Soy el círculo. | 4 | imágenes contando..... | 53 |
| Arriba - Abajo | 7 | Color negro | 57 |
| Dentro - Fuera..... | 9 | Repasa el número 6. | 60 |
| Azul | 11 | Colorea al tercer niño de la fila.... | 62 |
| Grande - Pequeño..... | 13 | Igual - Diferente..... | 71 |
| Encima - Debajo | 15 | Ovalo..... | 75 |
| Abierta - Cerrada..... | 17 | Número 9..... | 77 |
| Alto - Bajo..... | 19 | Número 10..... | 79 |
| El cuadrado | 22 | Color blanco..... | 88 |
| Amarillo..... | 24 | Direccionalidad | 89 |
| Junto - Separado | 26 | Reproducción de figuras..... | 92 |
| Muchos - Pocos..... | 29 | Secuencia por tamaño..... | 94 |
| Detrás - Delante..... | 31 | Pega aquí:..... | 95 |
| Número uno..... | 33 | Color Morado | 96 |
| El triángulo..... | 38 | Conjuntos | 97 |
| Largo - Corto..... | 40 | Secuencia de colores..... | 99 |
| Repasa con témpera el | | | |
| número 4..... | 50 | | |



Color

Rojo



Pega papel rasgado de color rojo (●) sobre la manzana.

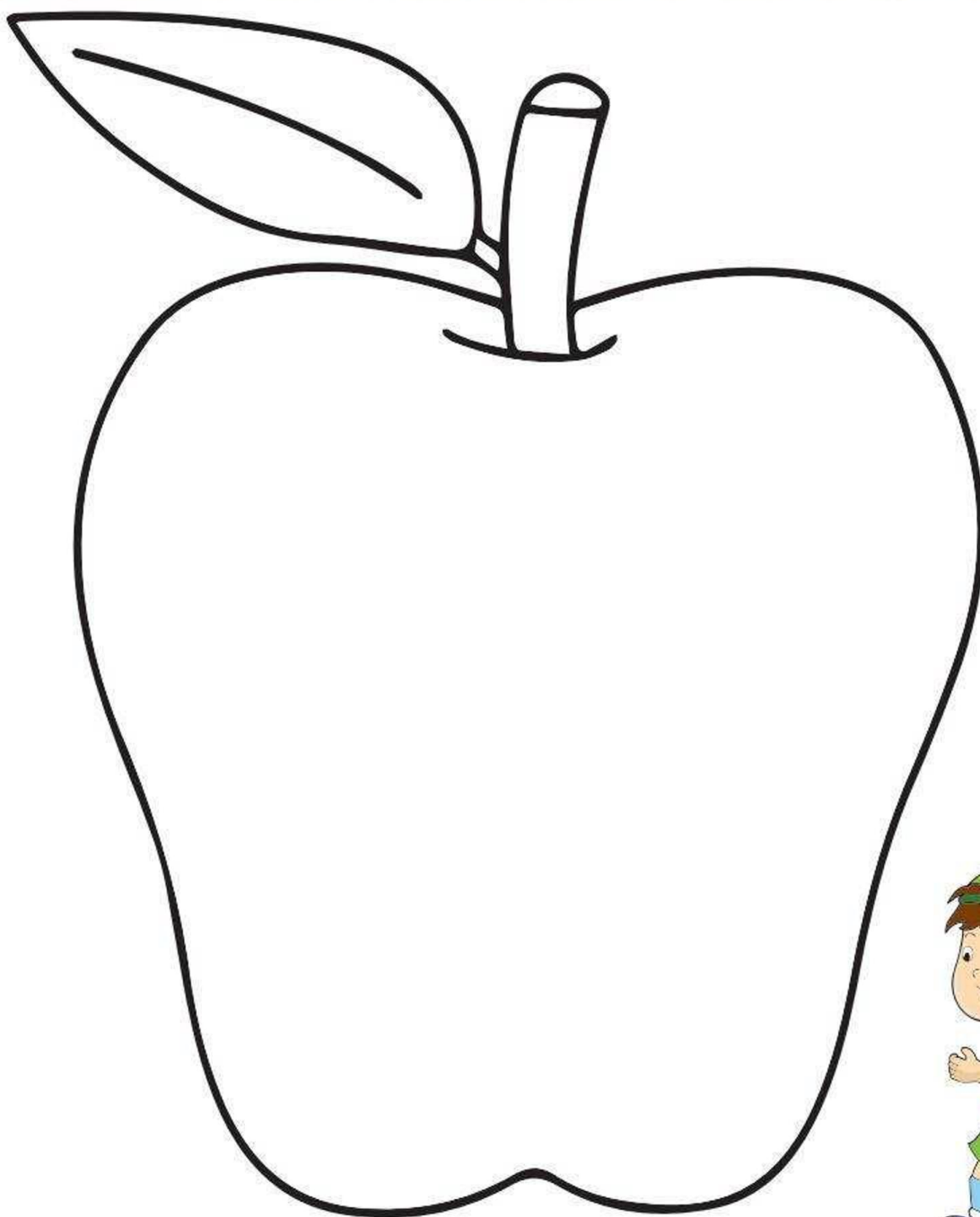

Círculo



Pinta el círculo con crayola de color rojo (●)

Soy el círculo.
Repasa mi exterior y
colorea mi interior.

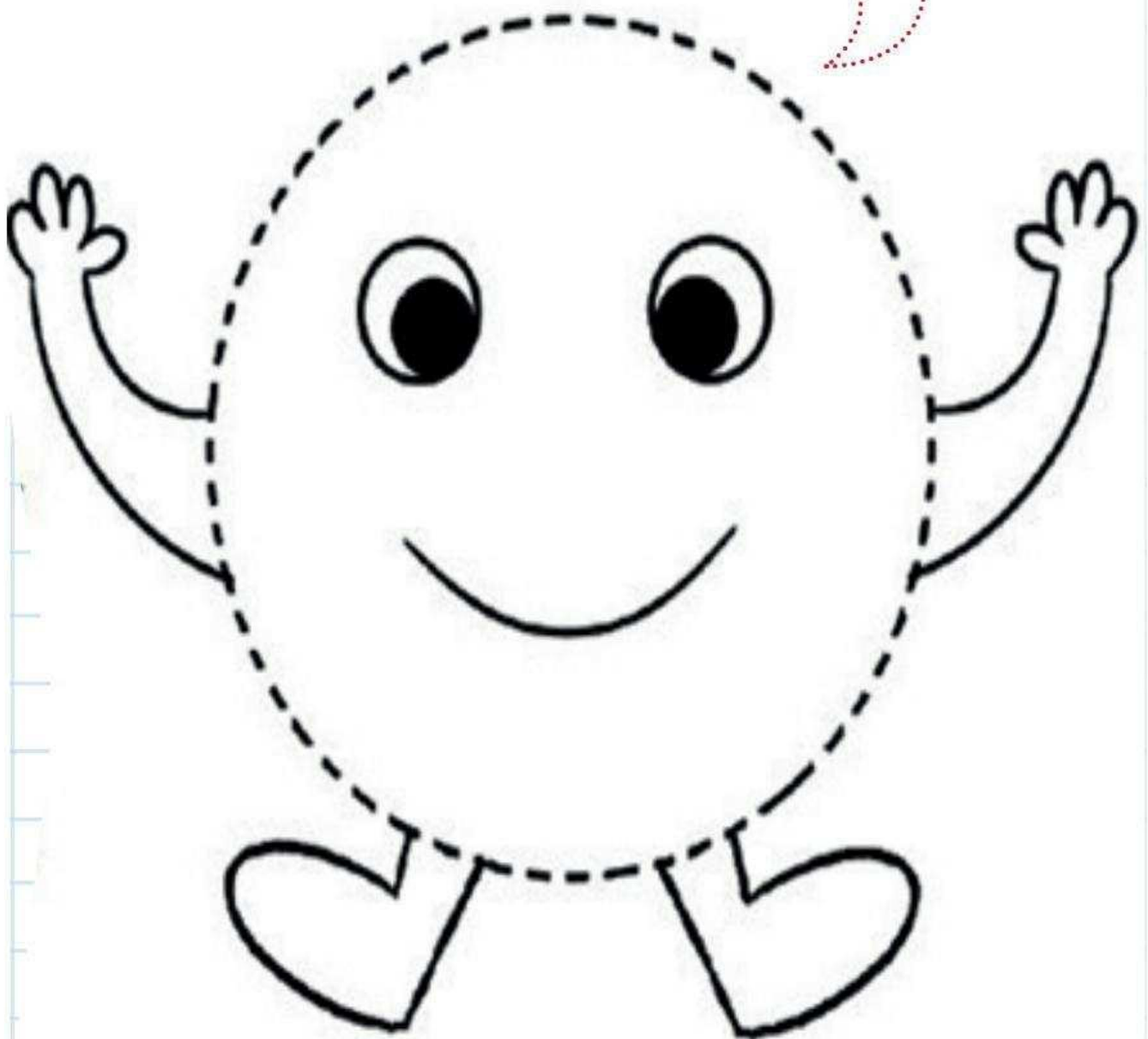



Pega bolitas de plastilina alrededor del circulo.

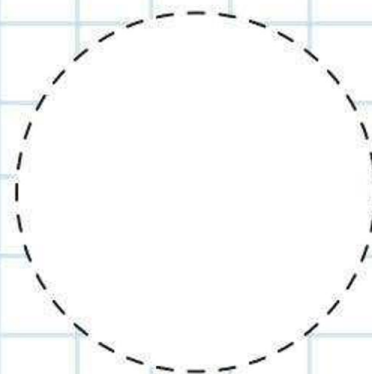
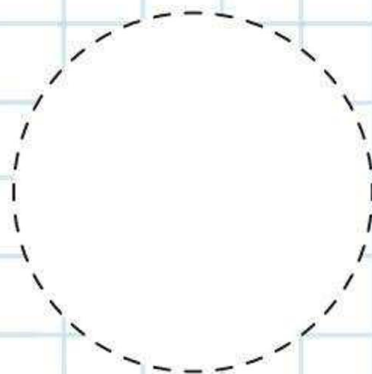
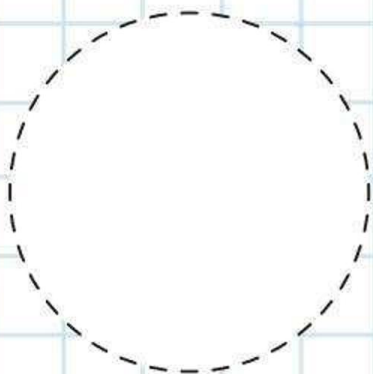
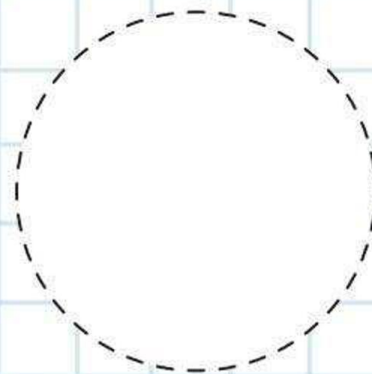
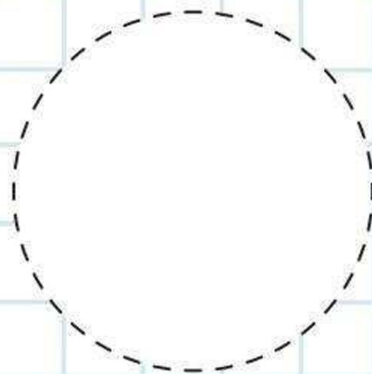
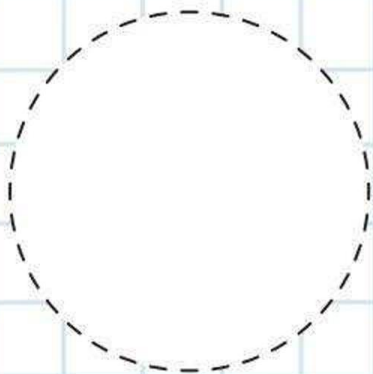
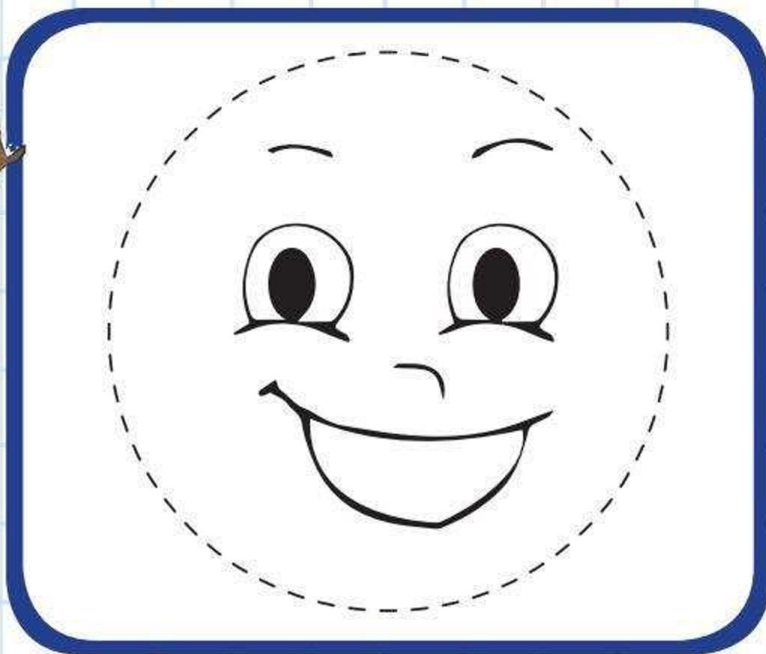

◆ Deja tus huellitas con t mpera por los  rculos de color rojo.

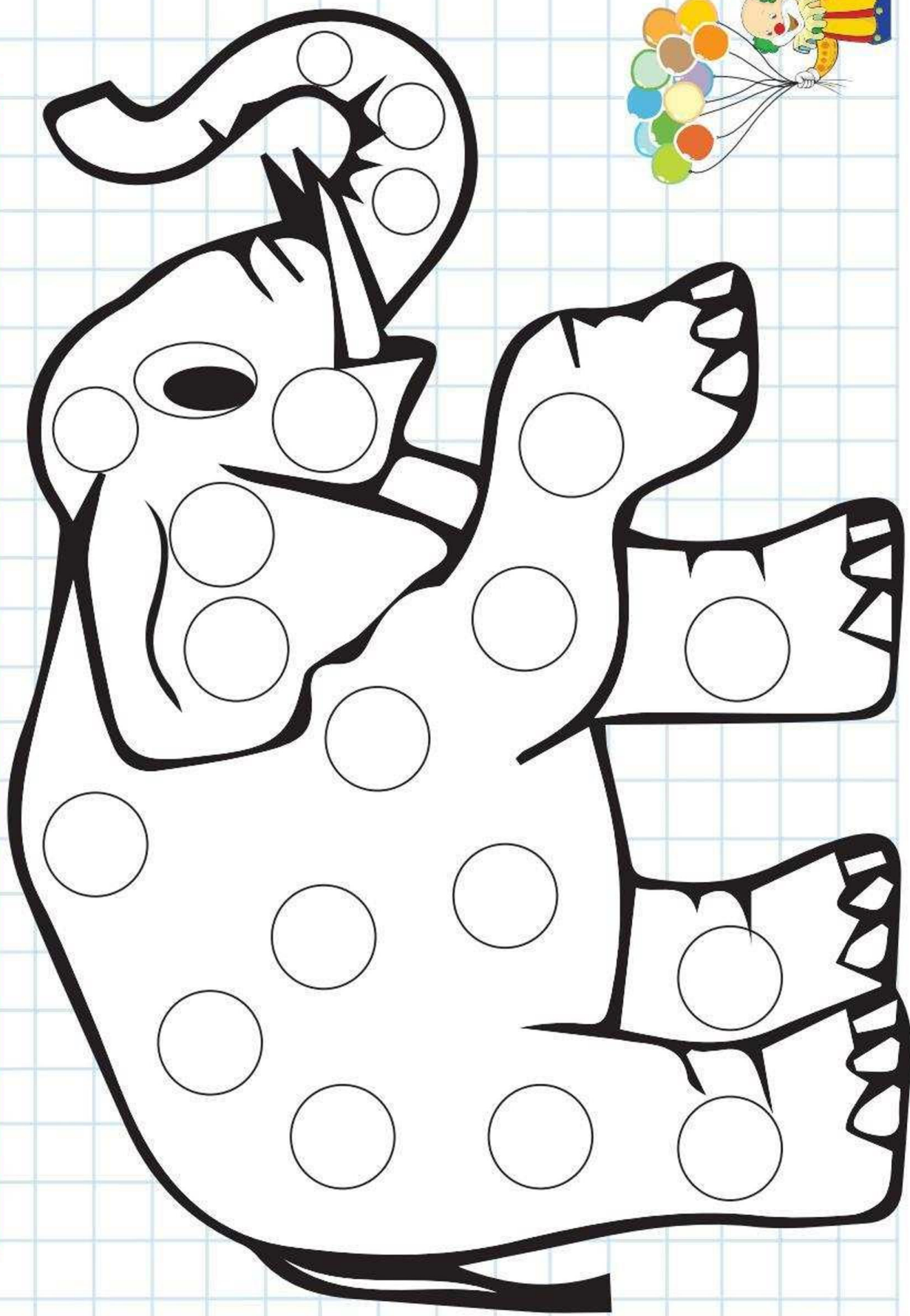

Arriba - Abajo



Marca con una (X) las manzanas que están arriba del árbol y encierra en un círculo (O) las manzanas que están abajo del árbol.

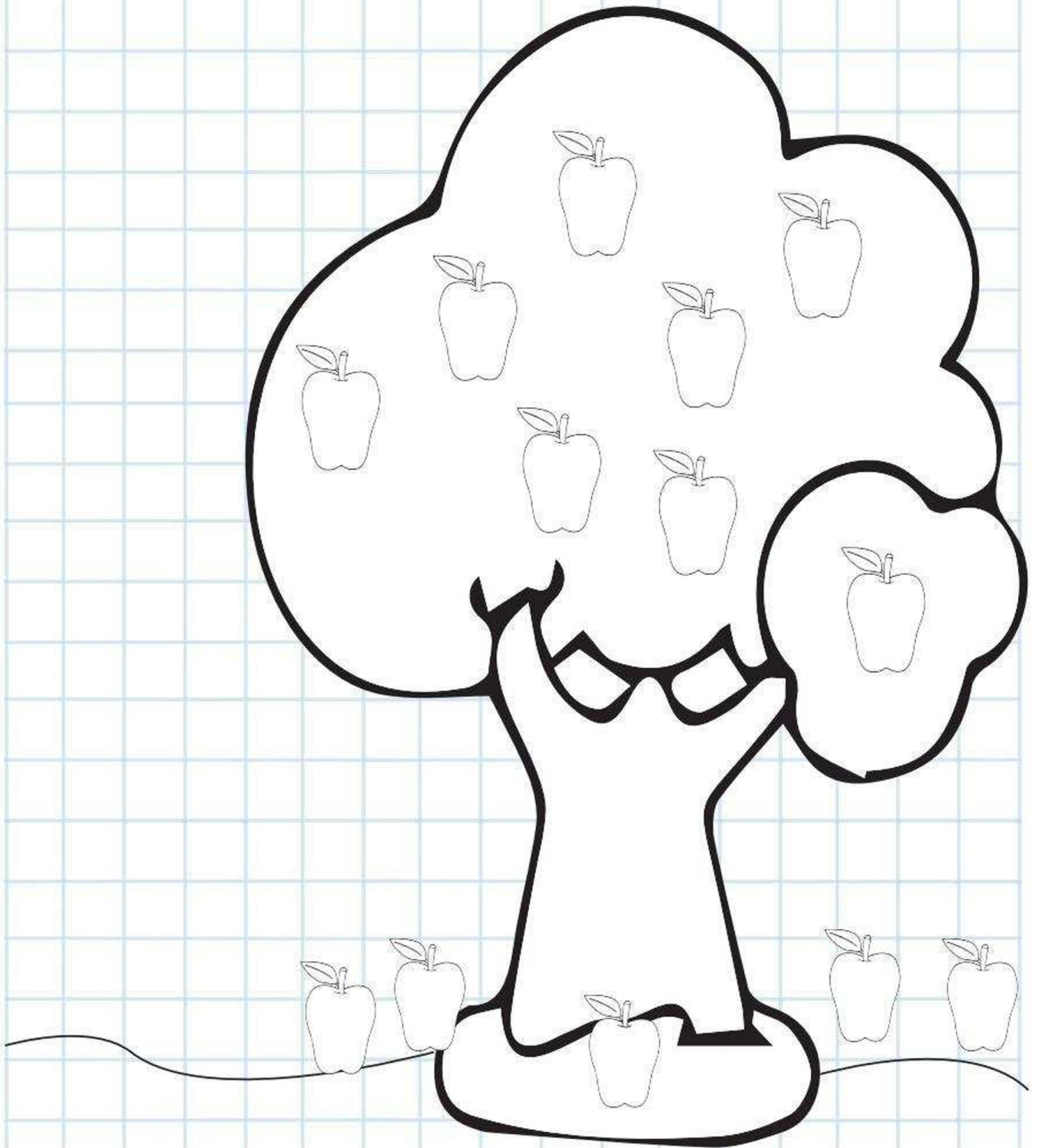

Imita las acciones del niño con guía de tu profesora.



Dentro – Fuera

◆ Pega plastilina al redor de la niña que está afuera de la casa.





Colorea el gato que está dentro de la canasta.

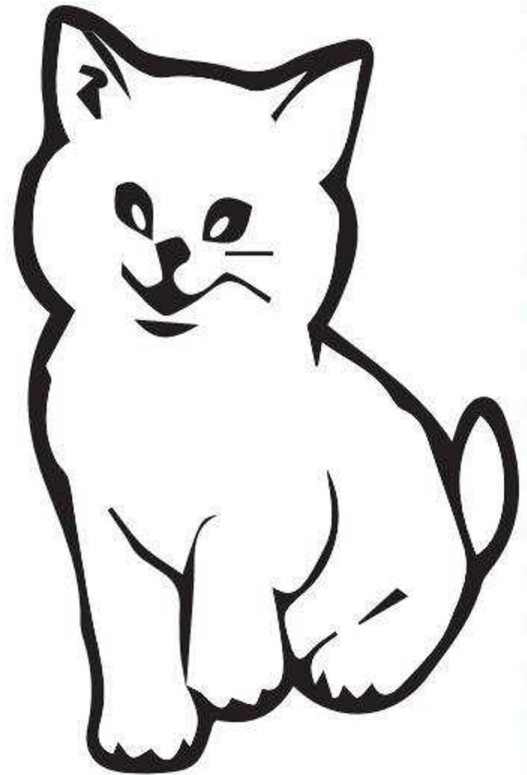

Color

Azul

❖ Deja tus huellitas con t mpera azul en el carro.

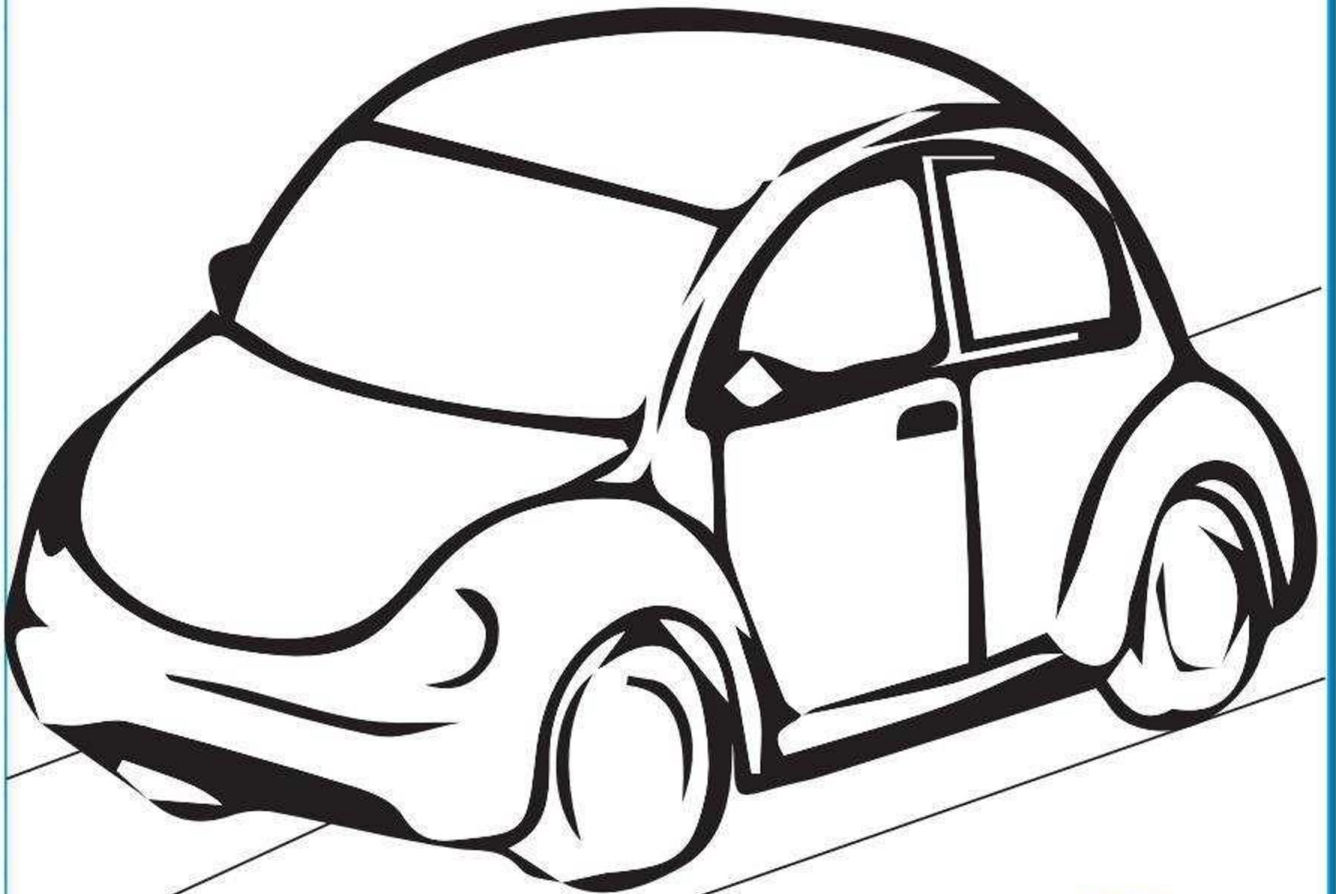



Colorea el short de color azul.

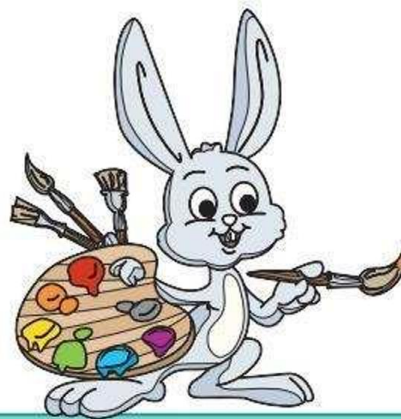

Grande – Pequeño

Colorea al animalito que es más grande y marca (X) el más pequeño.

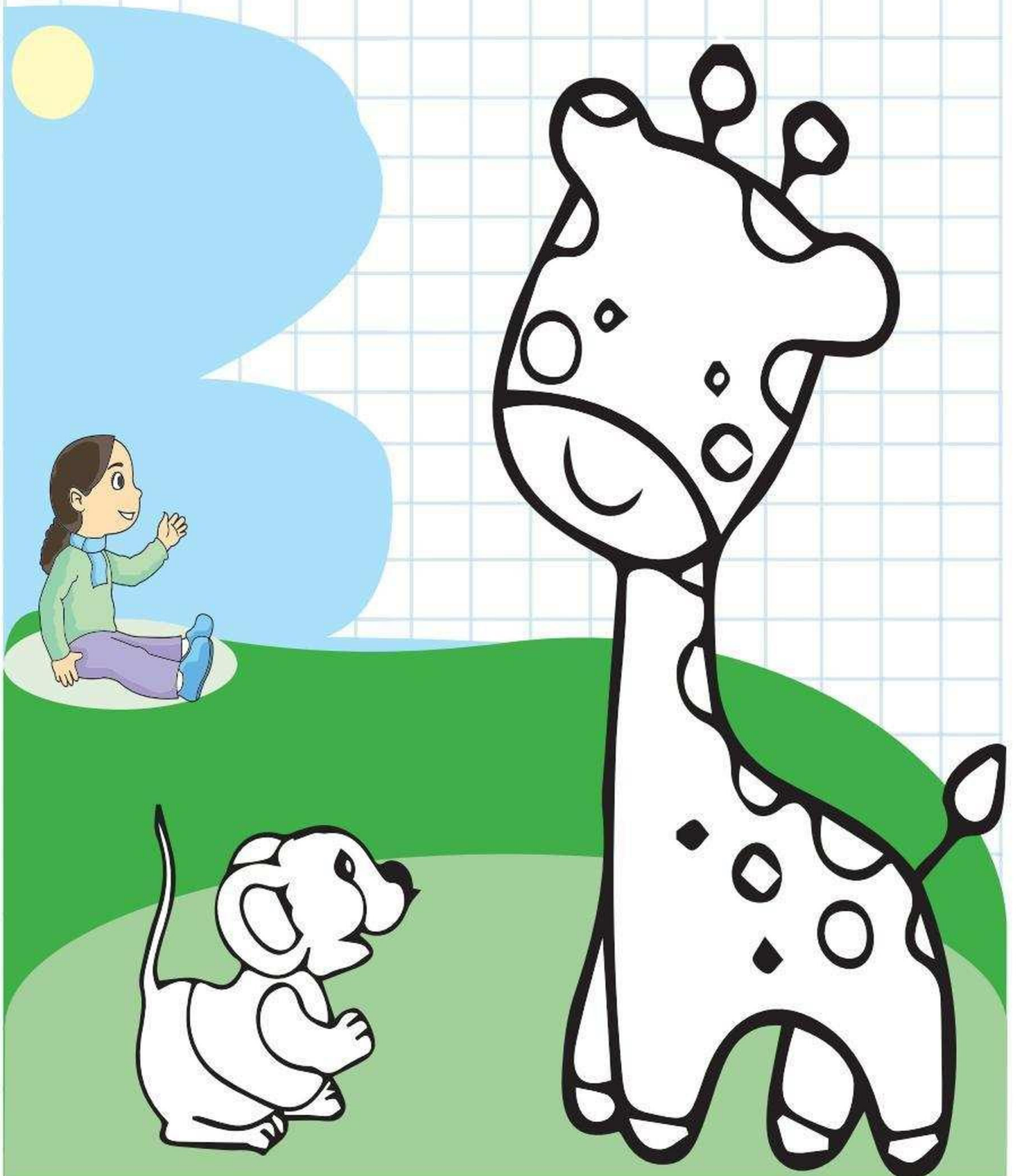



Pega plastilina en el caracol grande.



Encima – Debajo



Encierra a la niña que está encima de la mesa.





Embolilla papel en la pelota que está abajo de la mesa y pinta la pelota que está encima.

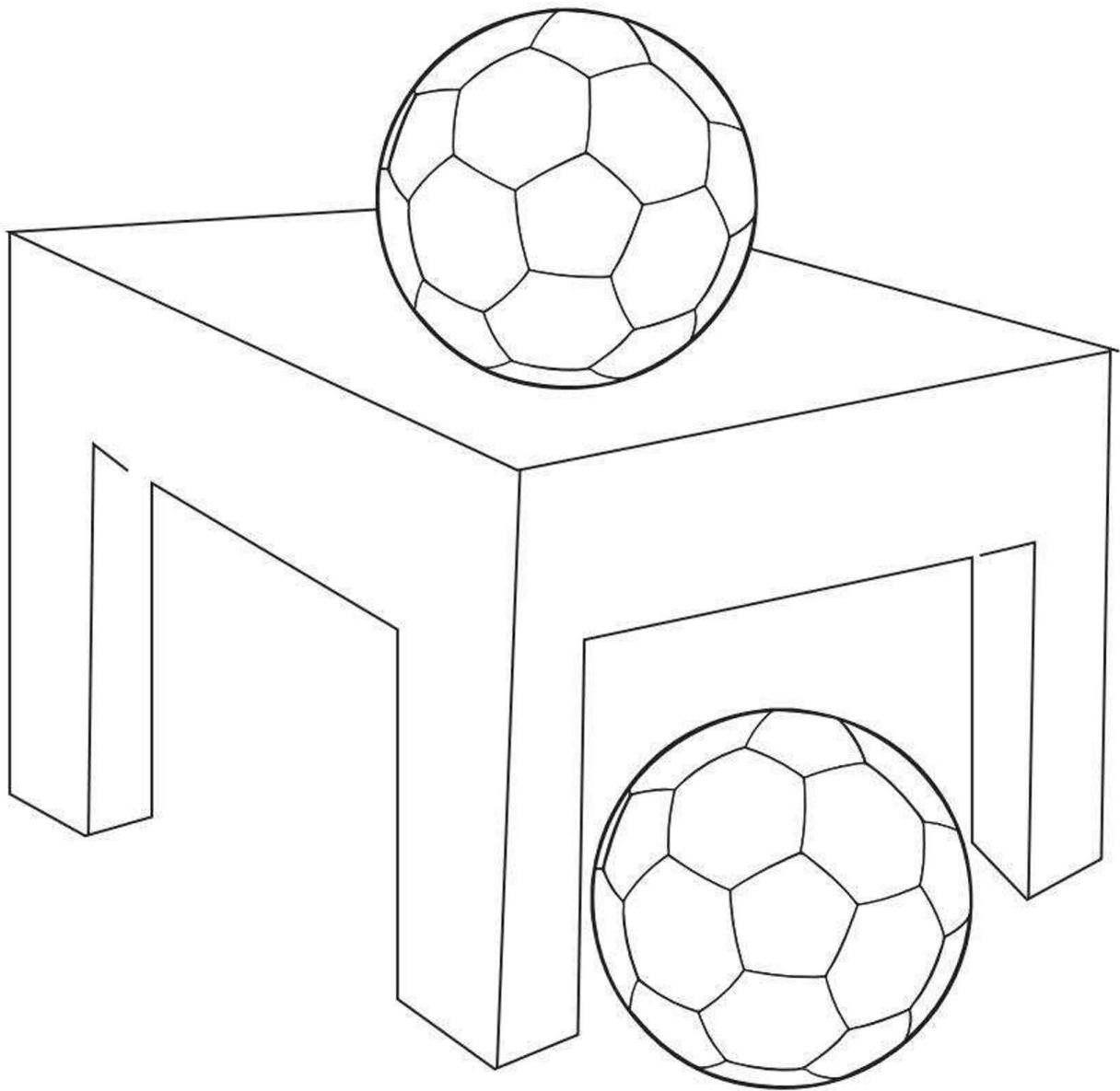

Abierta - Cerrada

Colorea la caja cerrada.

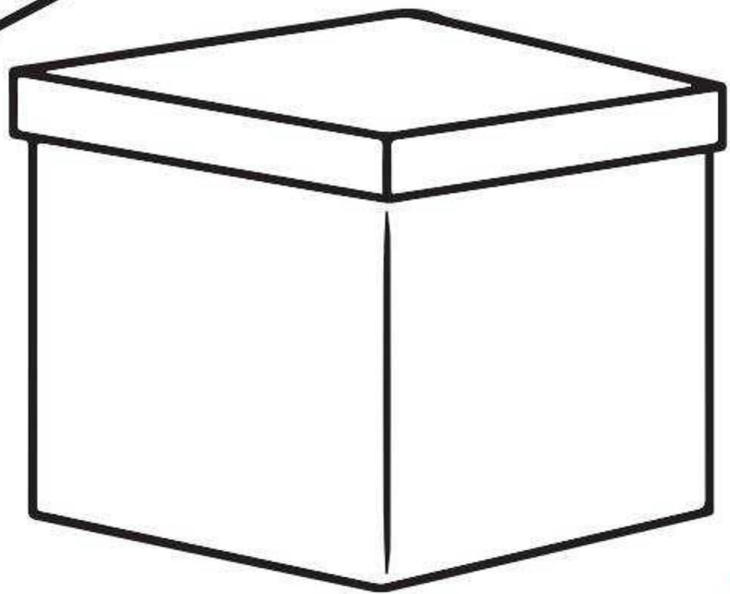
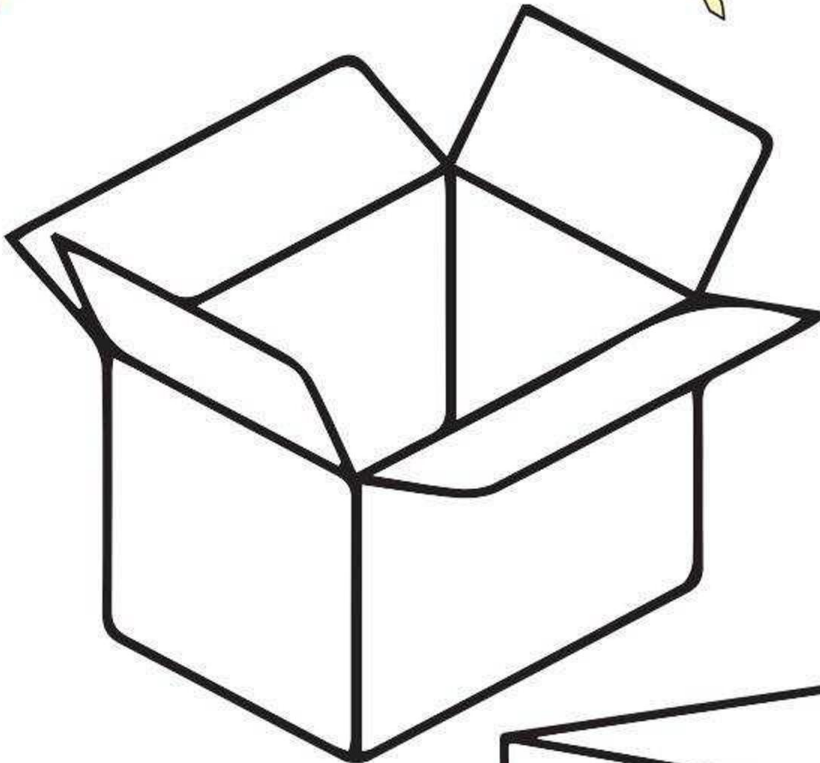



Pega serpentina al borde de la puerta abierta y marca (X) la puerta cerrada.

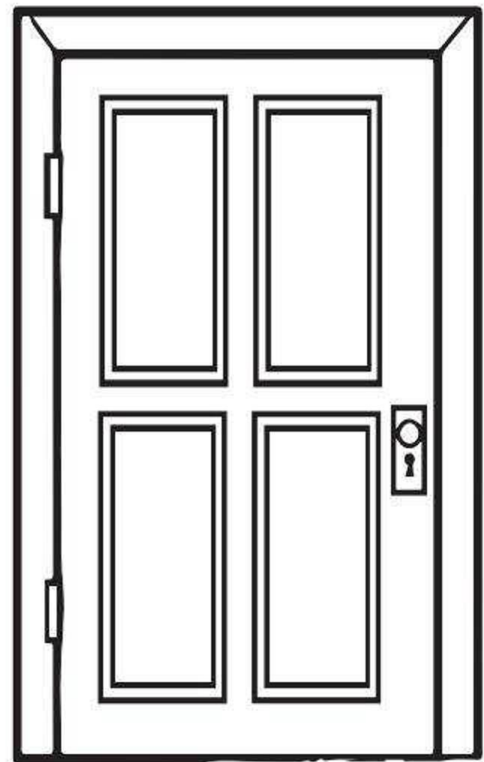
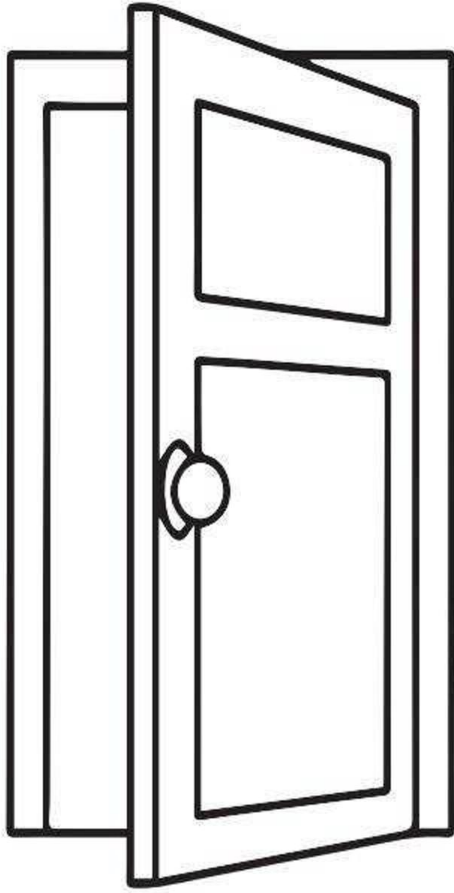

Alto - Bajo

Colorea el animalito más alto de amarillo.

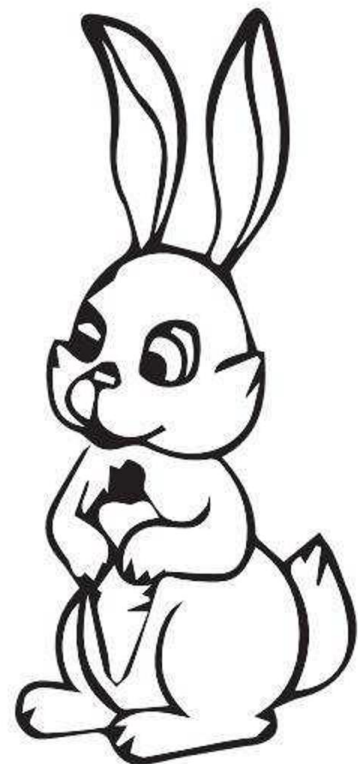



Rasga papel en el árbol bajo y encierra (O) el árbol alto.

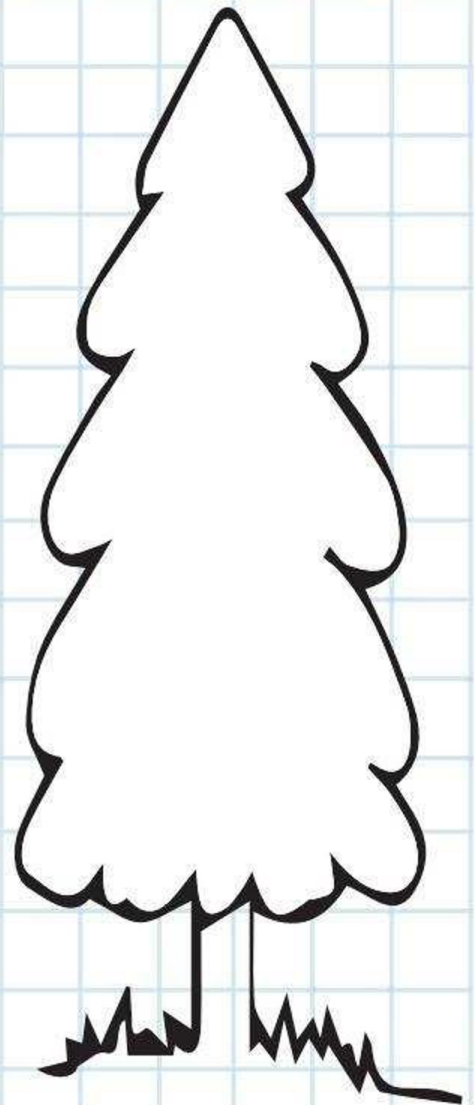
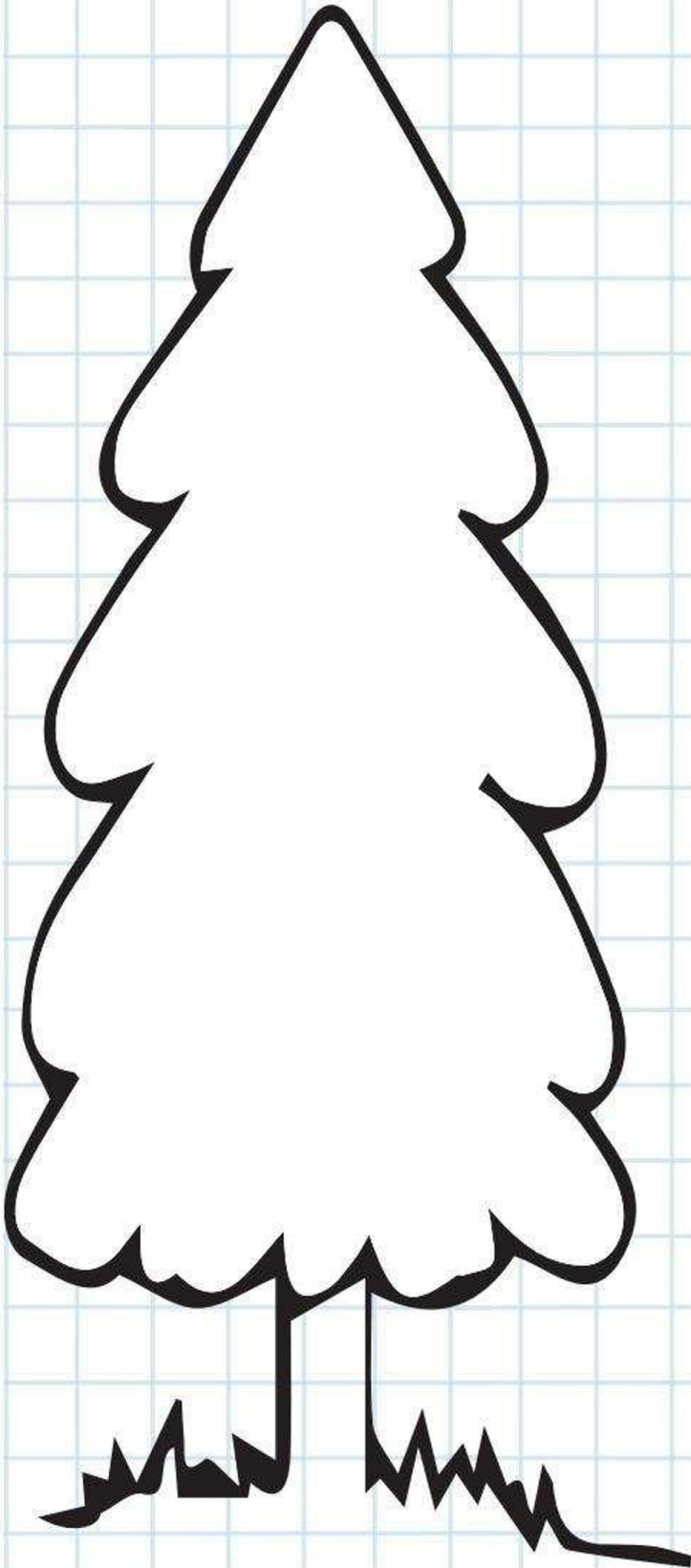



Pega escarcha en la flor más alta.

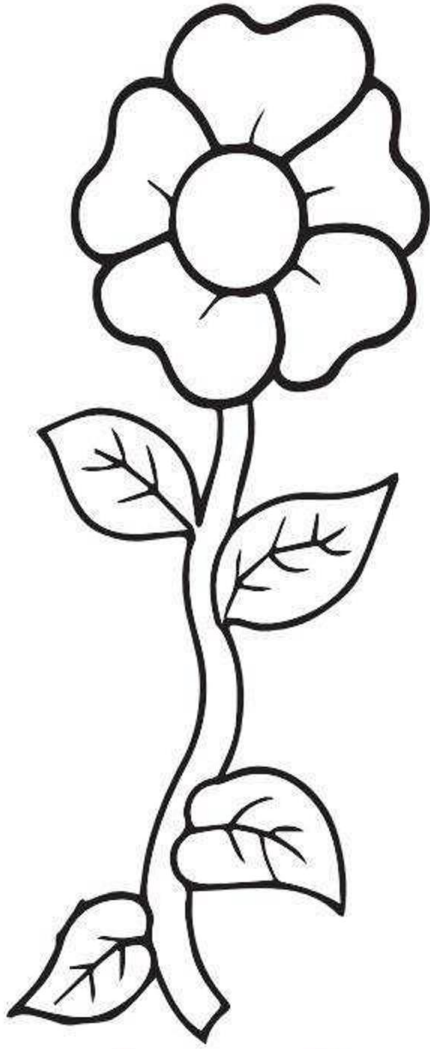
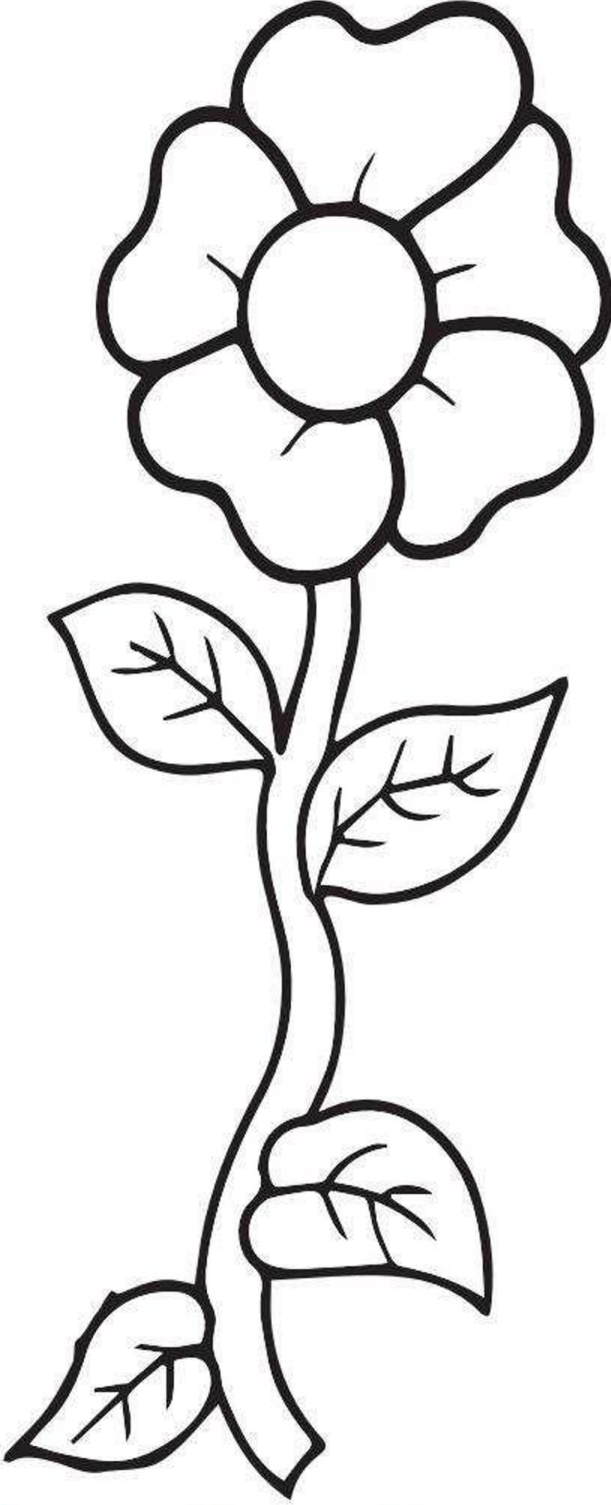

El cuadrado

❖ Embolilla papel azul al borde del cuadrado.

Soy el cuadrado.
Repasa mis cuatro
lados y coloréame.

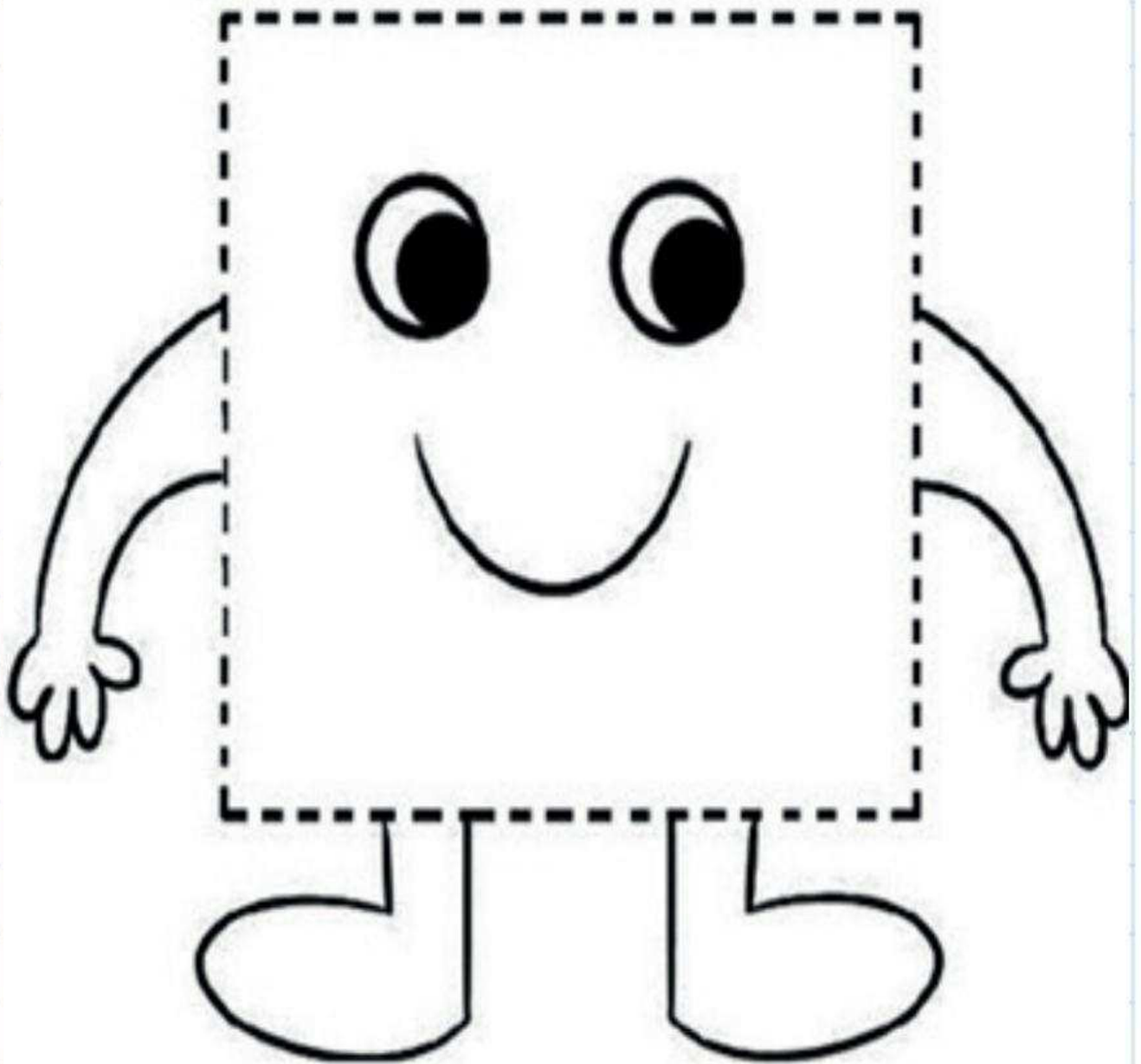

Traza el cuadrado con plumón.

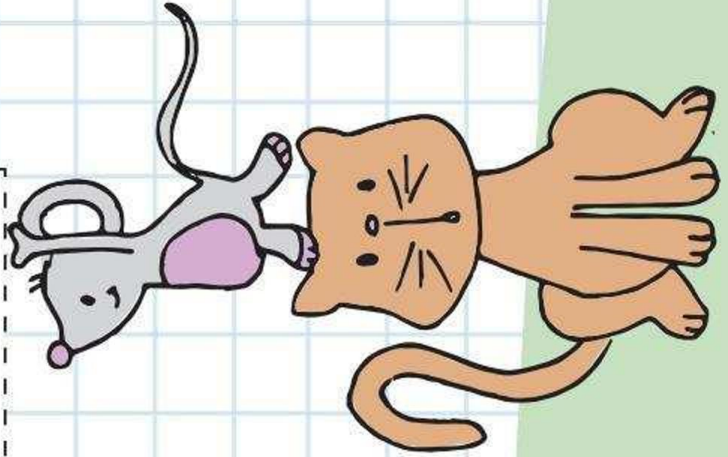
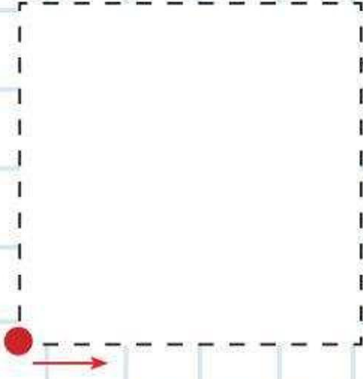
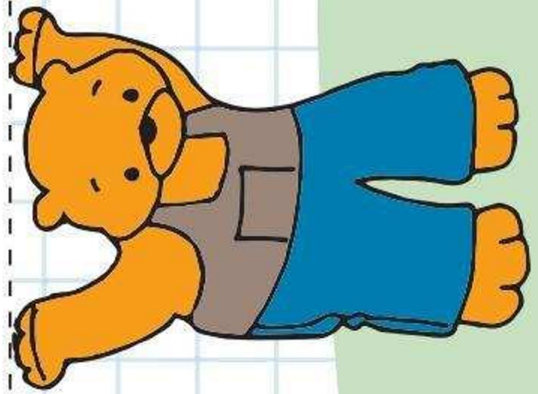
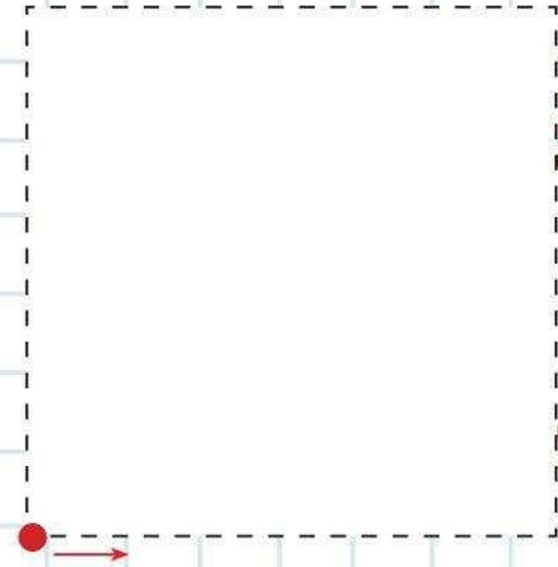

Color

Amarillo

- ❖ Deja tus huellitas con t mpera amarilla dentro del pollito.

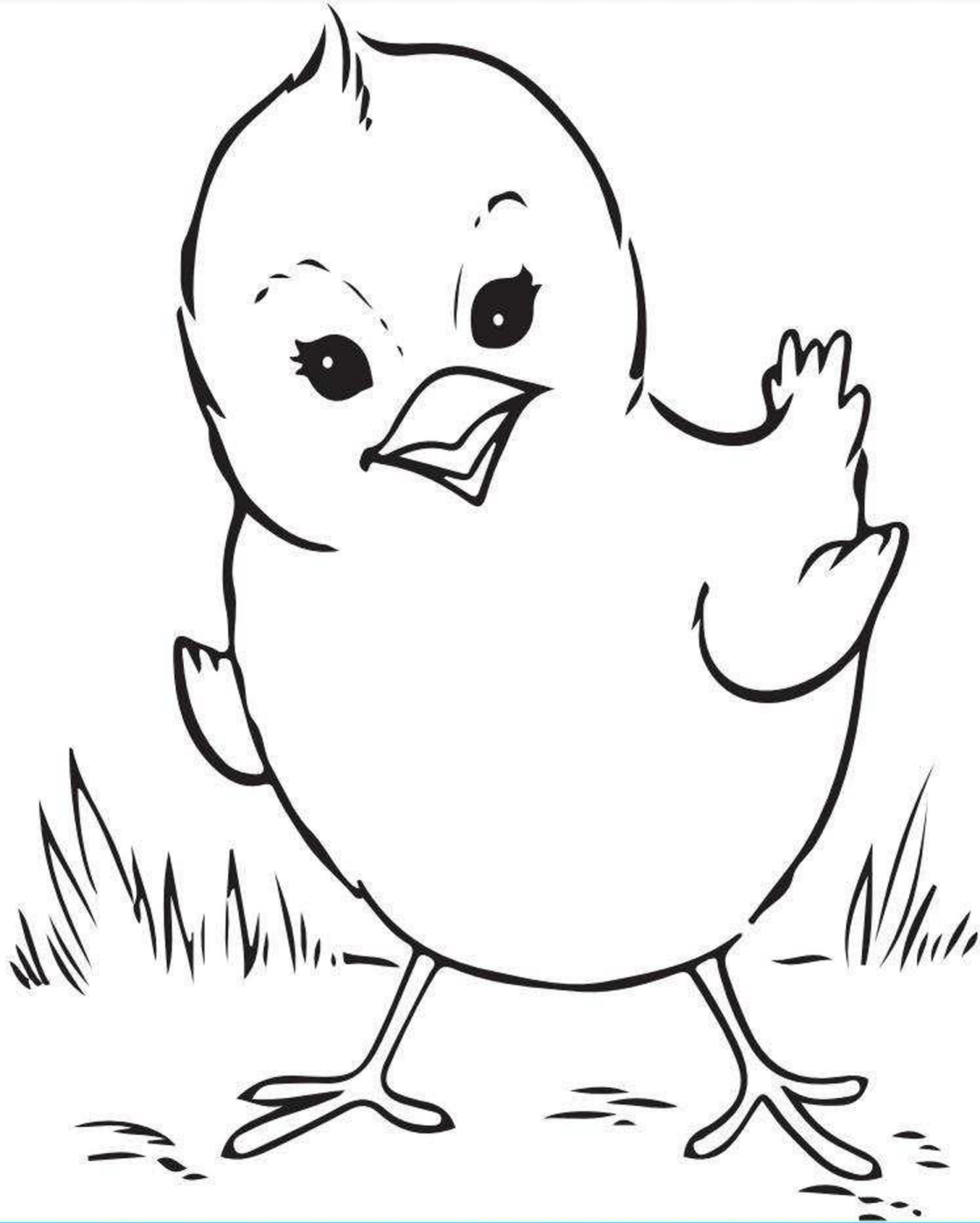



Colorea el plátano de color amarillo con tempera.

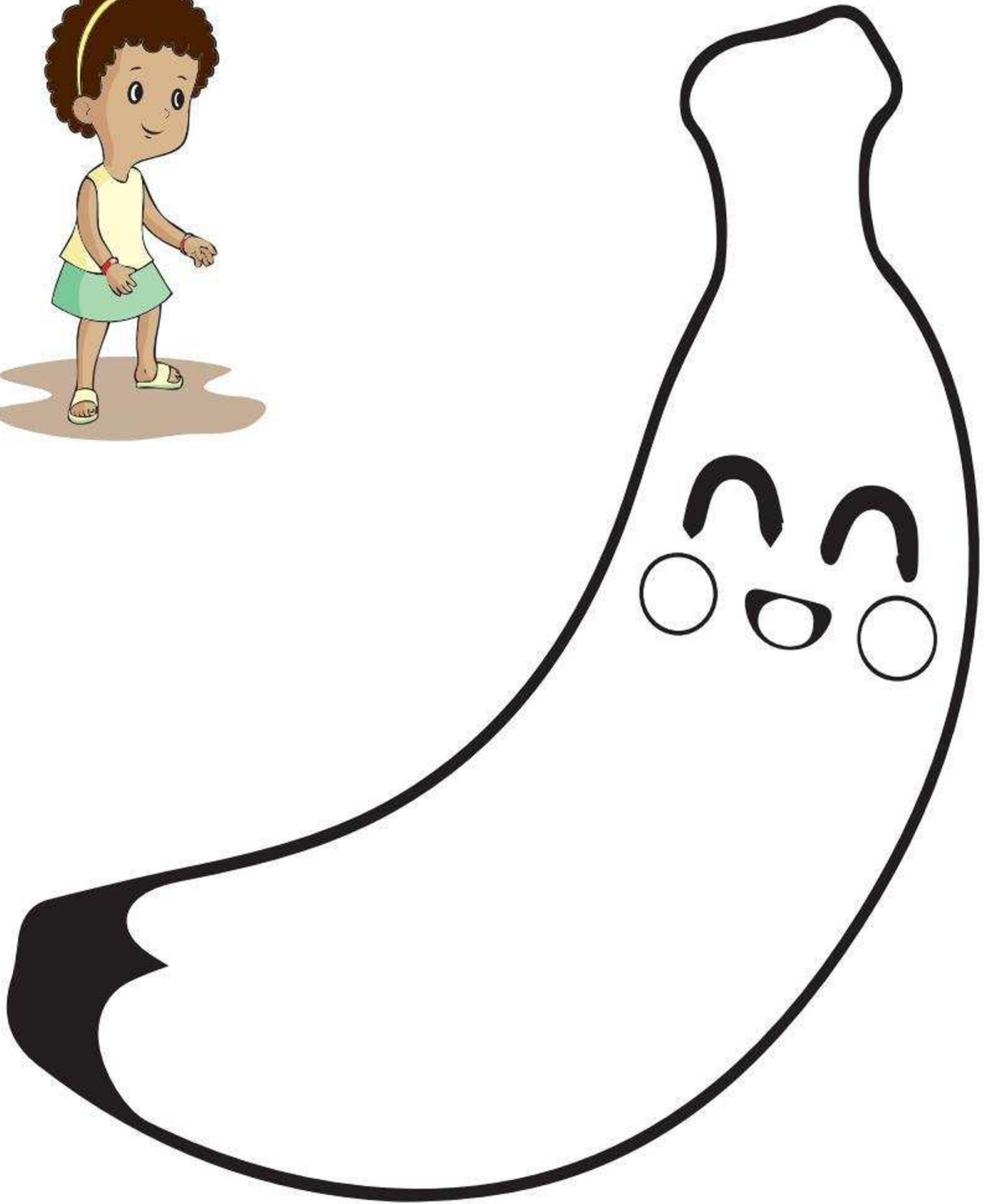

Junto – Separado



Encierra y colorea a los niños que se encuentran juntos: luego marca (X), a los que se hallan separados del grupo.





Embolilla y encierra los animalitos que están juntos.

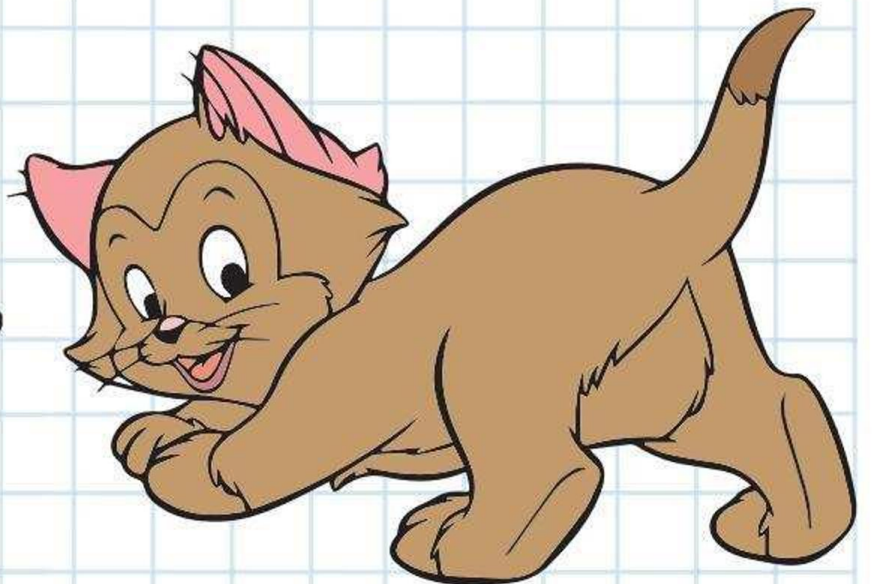
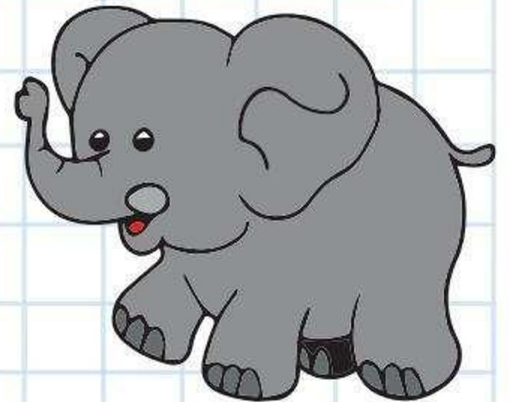



Colorea los pinceles separados y marca (X) los pinceles juntos.

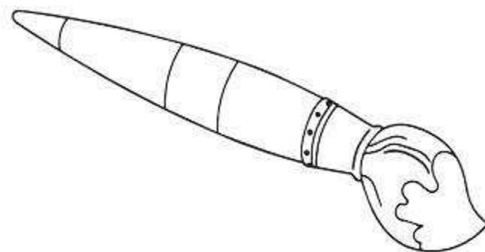
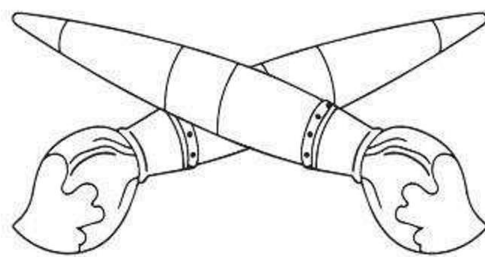
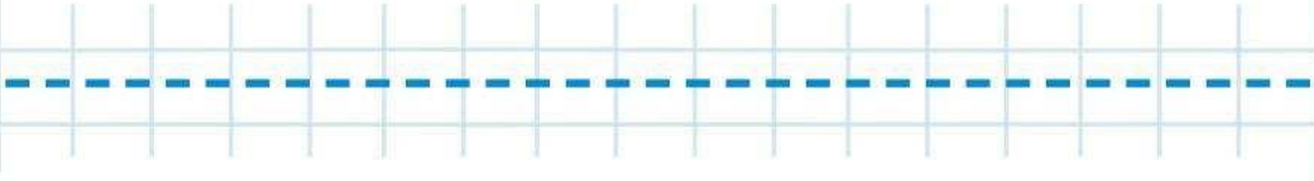
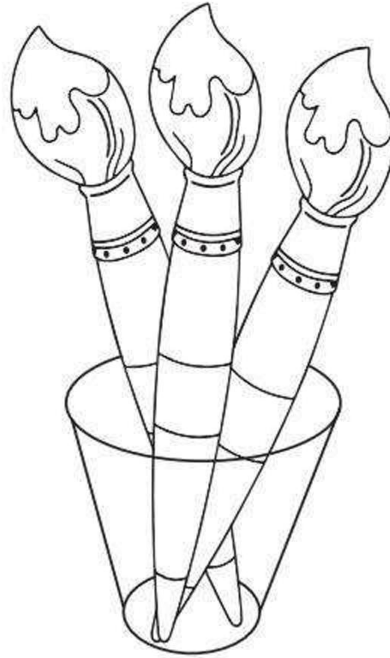

Muchos – Pocos

Marca (X) donde hay muchos niños.

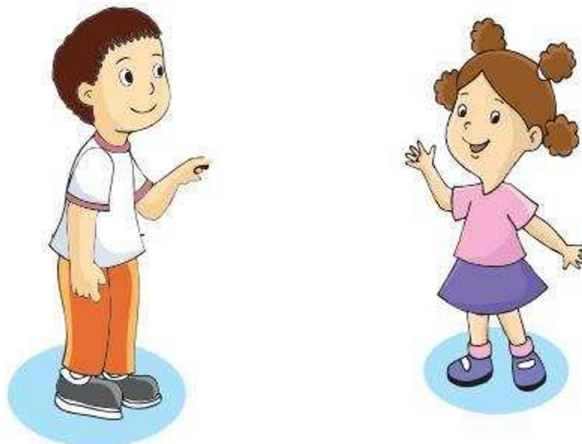
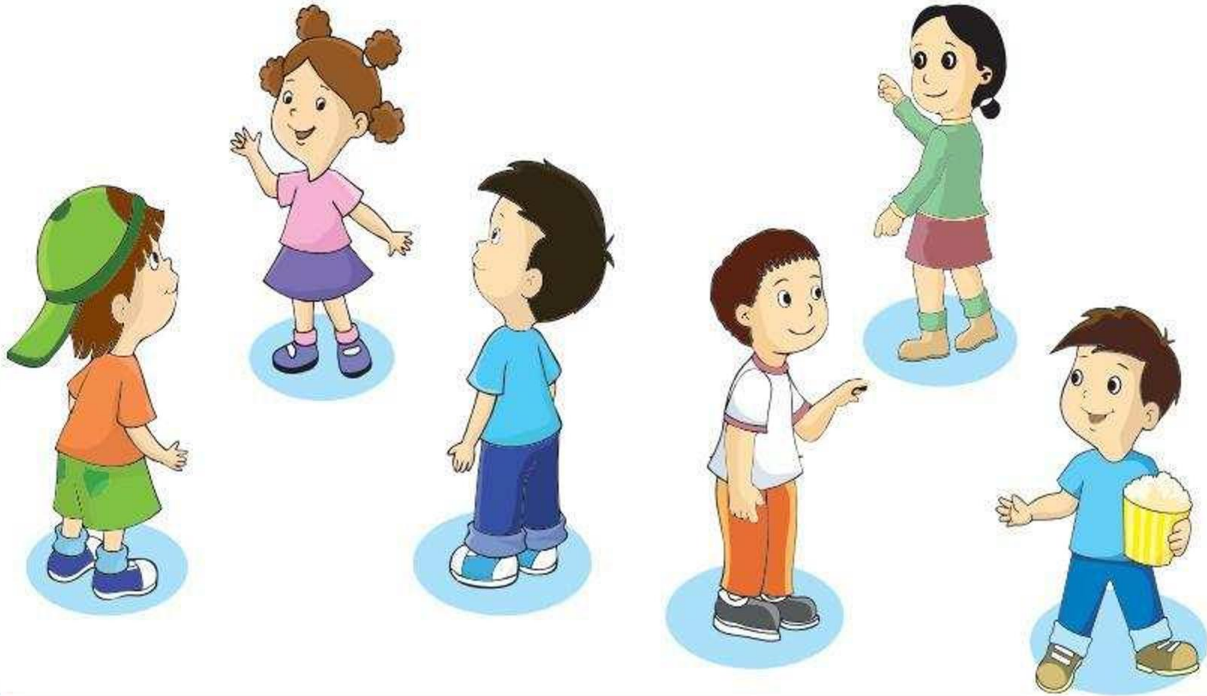



Colorea donde hay muchas paletas.

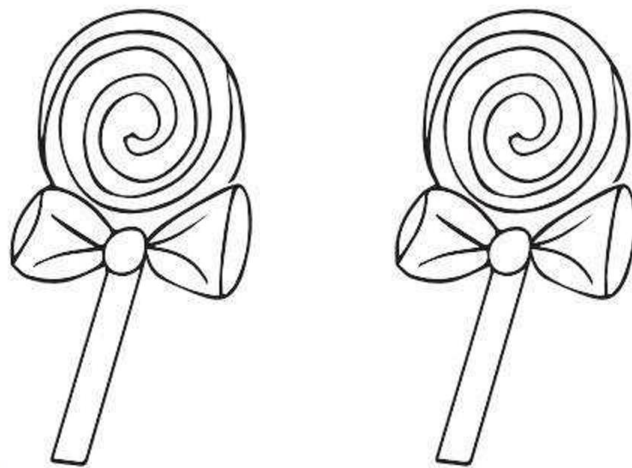
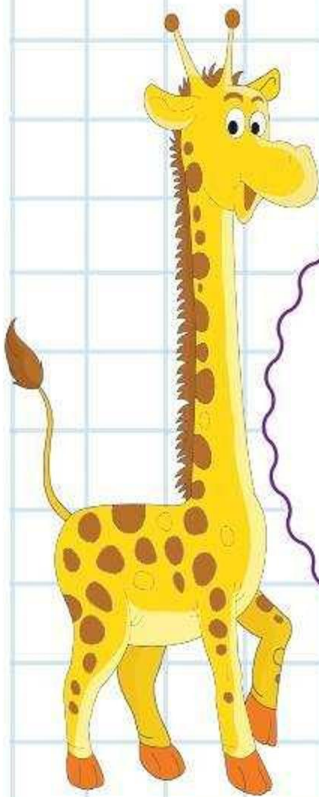
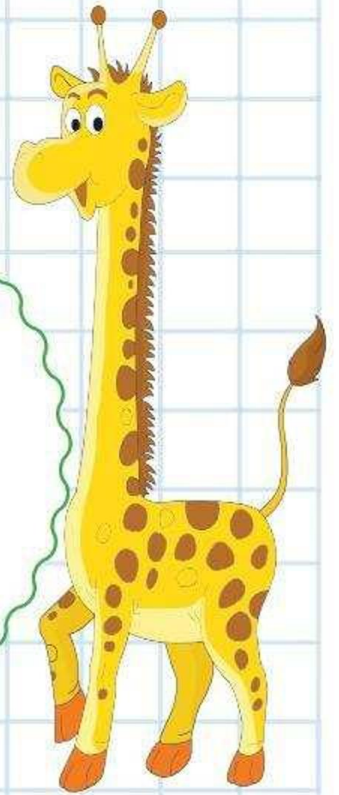

Detrás – Delante

Punza el borde del niño que está detrás de la silla.





Marca (X) al niño que está delante de su padre.

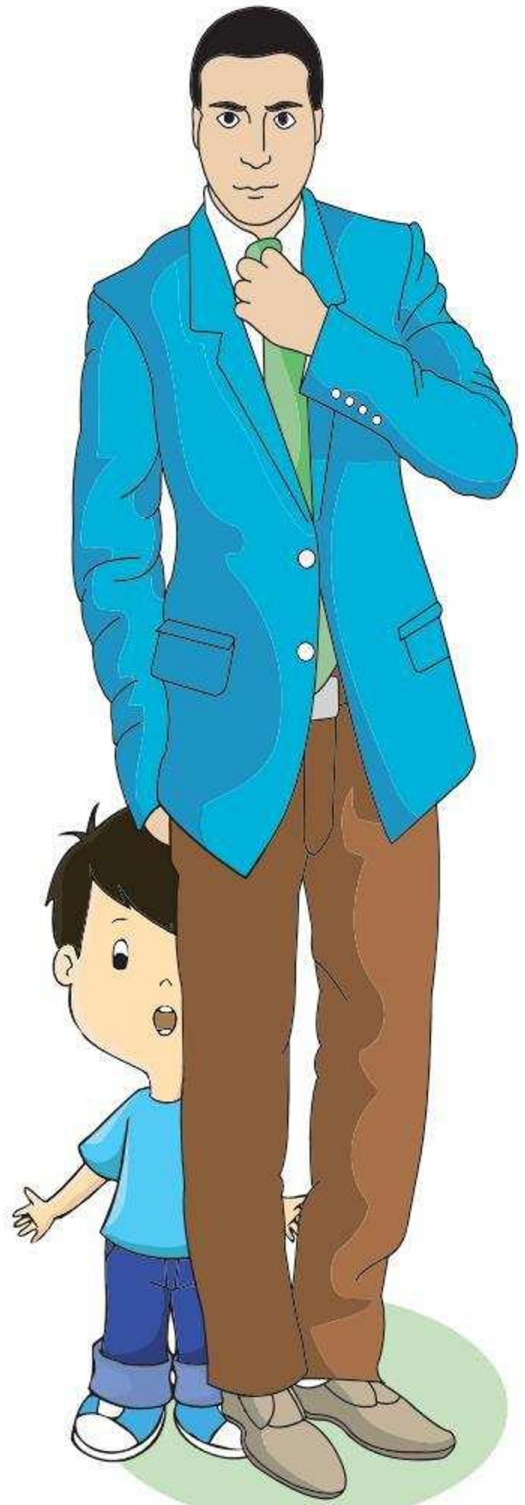
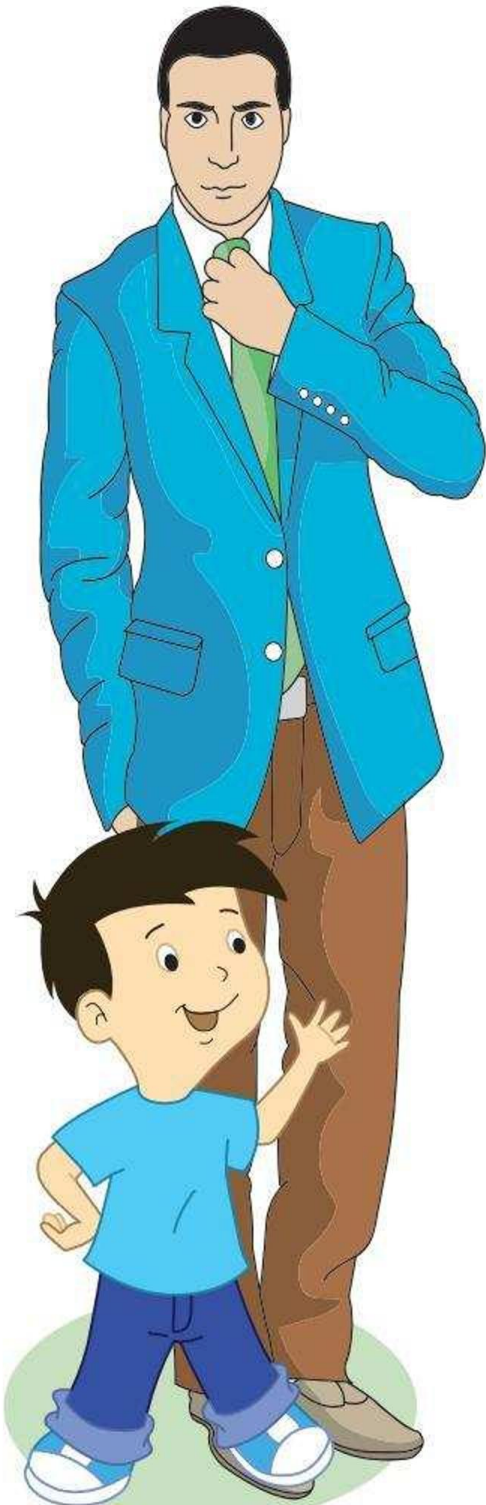

Número uno

Colorea el pollito y pega bolitas de papel en el N° 1.

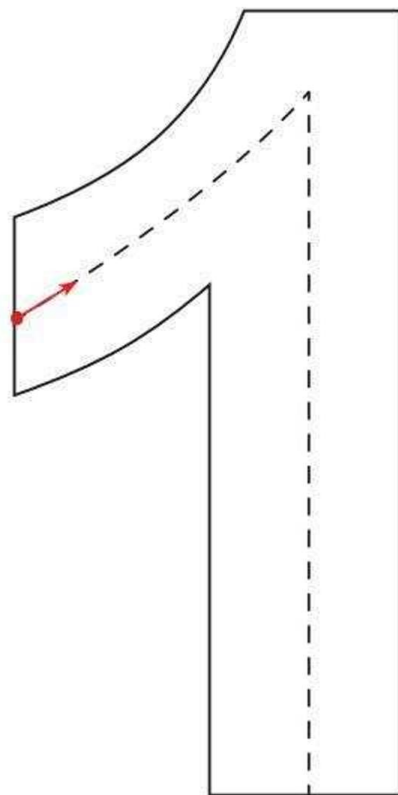
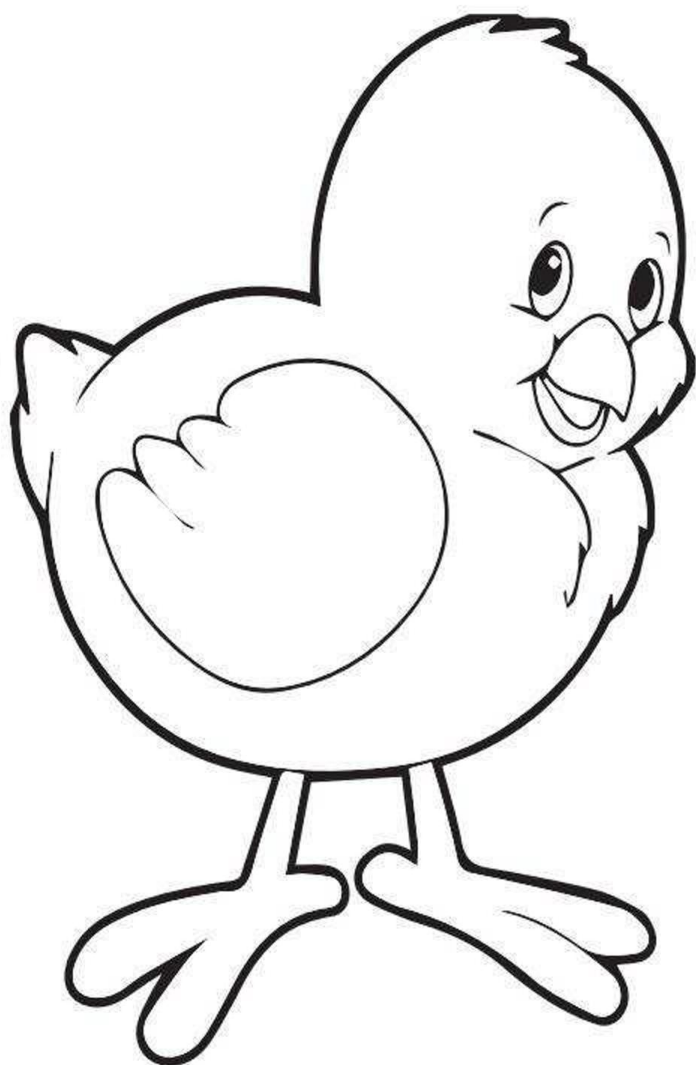



Repasa el número 1 con plumón grueso de color.

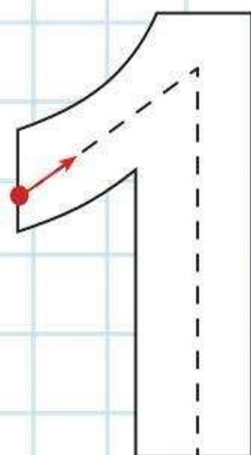
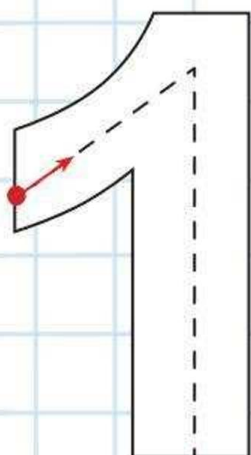
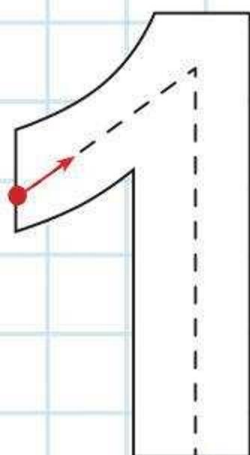
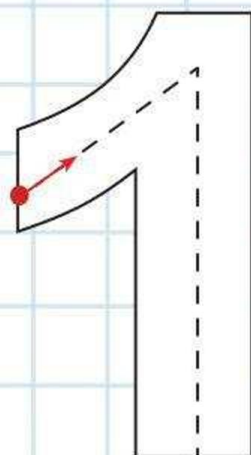
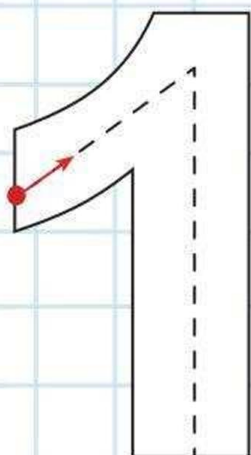
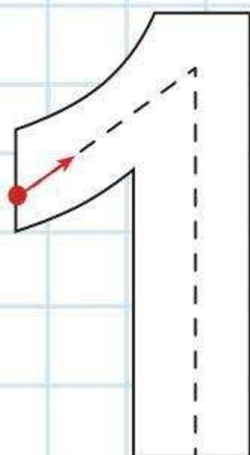
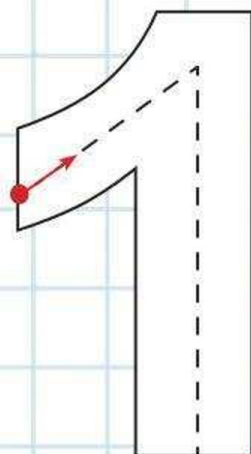
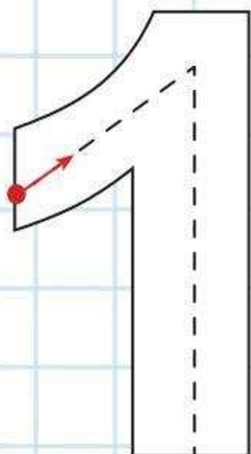
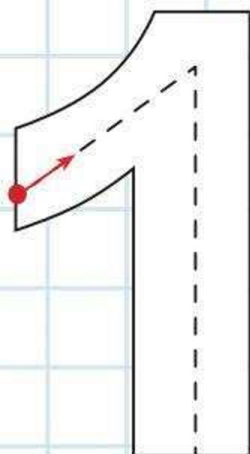

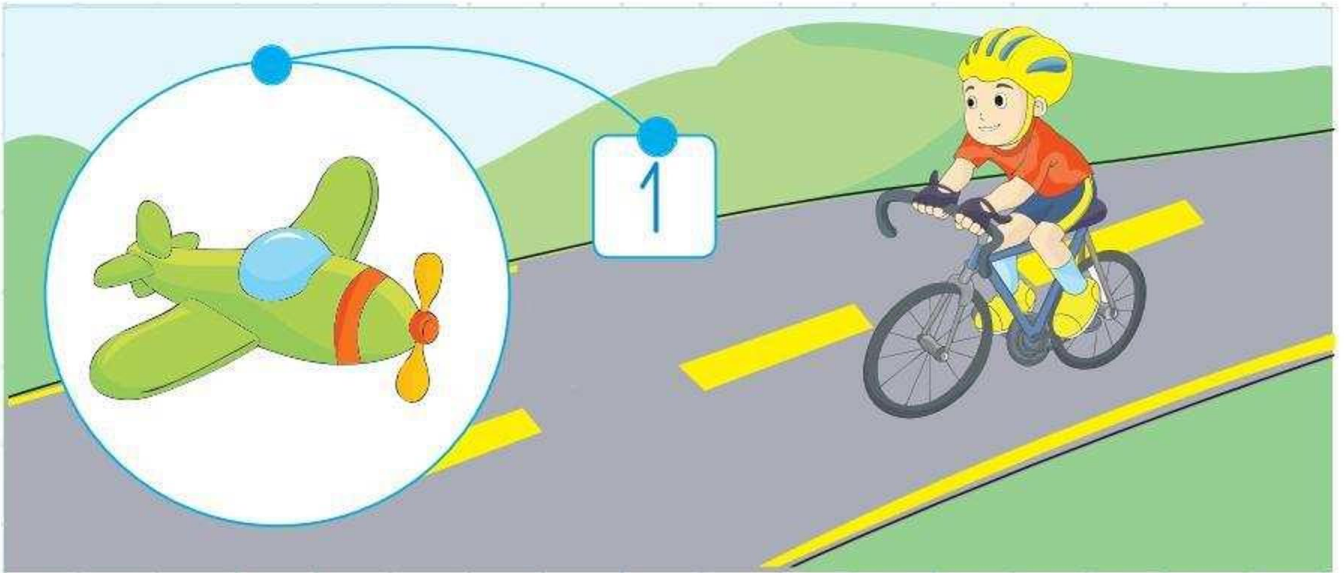

Pinta los conjuntos que tengan un elemento.

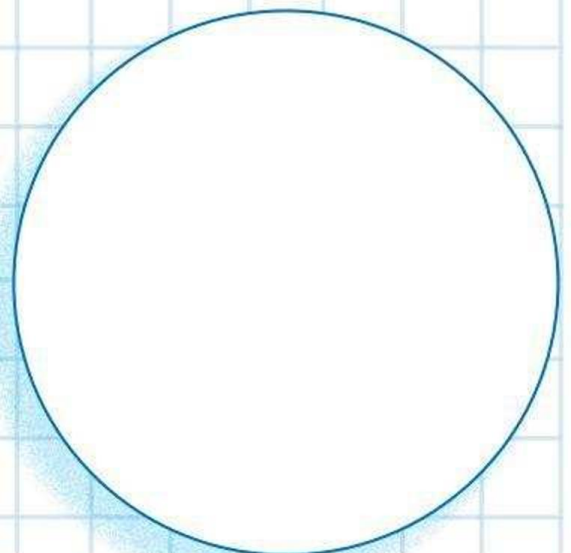
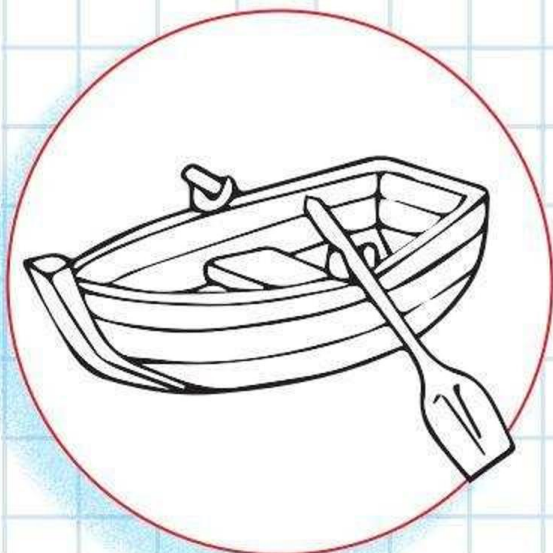
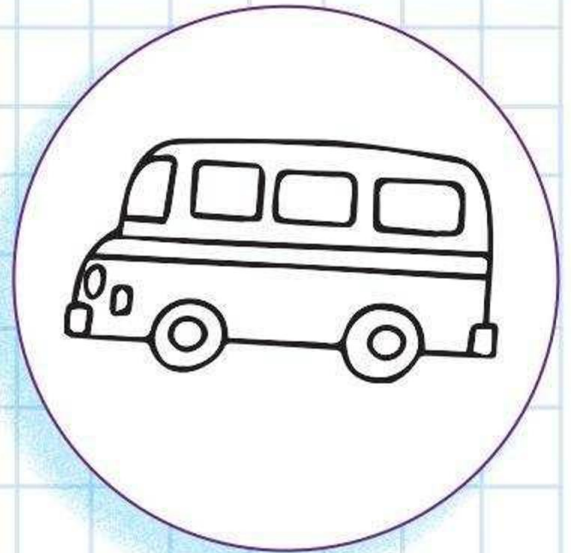
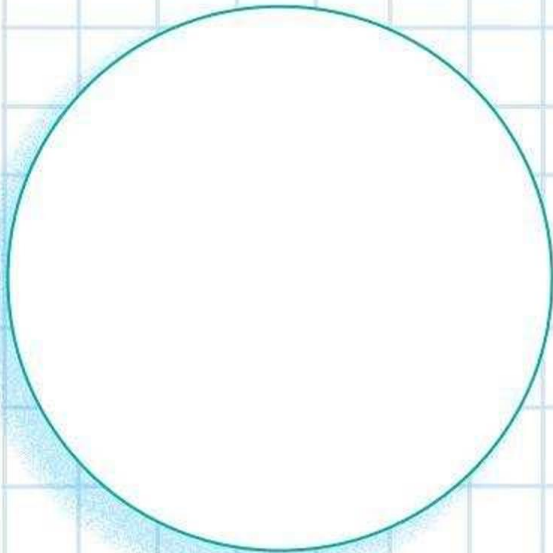



Une los números con la cantidad que corresponde.

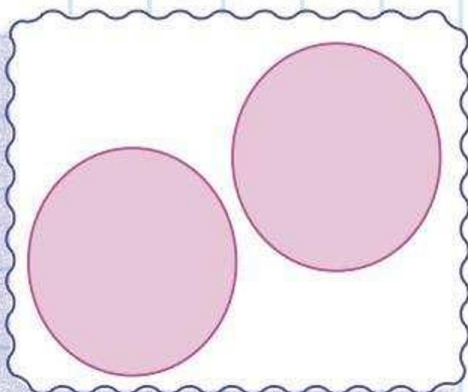
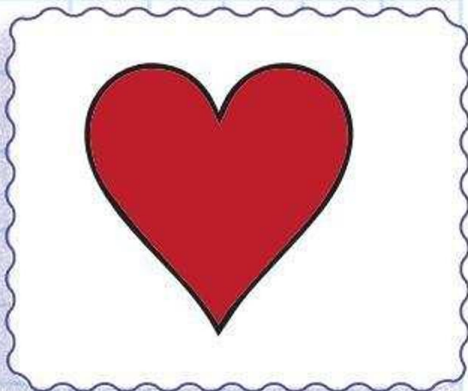
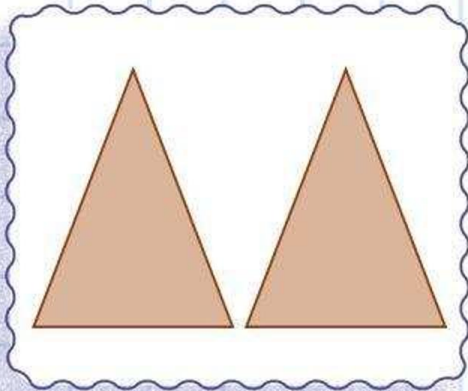
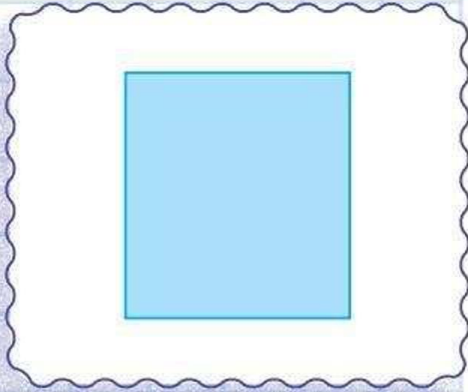

1

Encierra en círculo dos galletas.

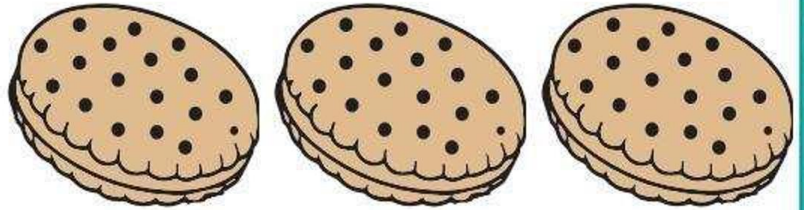

2

Colorea sólo dos chupetes.

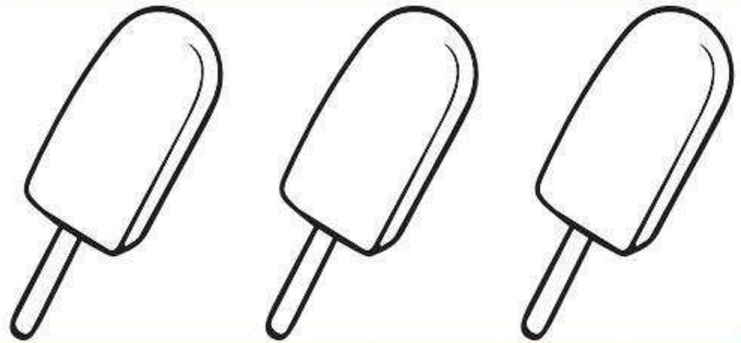

3

Marca con una (X) dos caballitos.

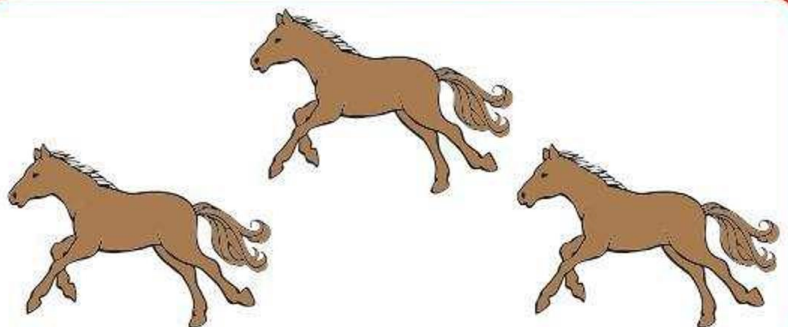

El triángulo

❖ Haz huellitas con tempera, por los puntitos del triángulo.

Soy el triángulo.
Repasa mis tres lados
y coloréame.

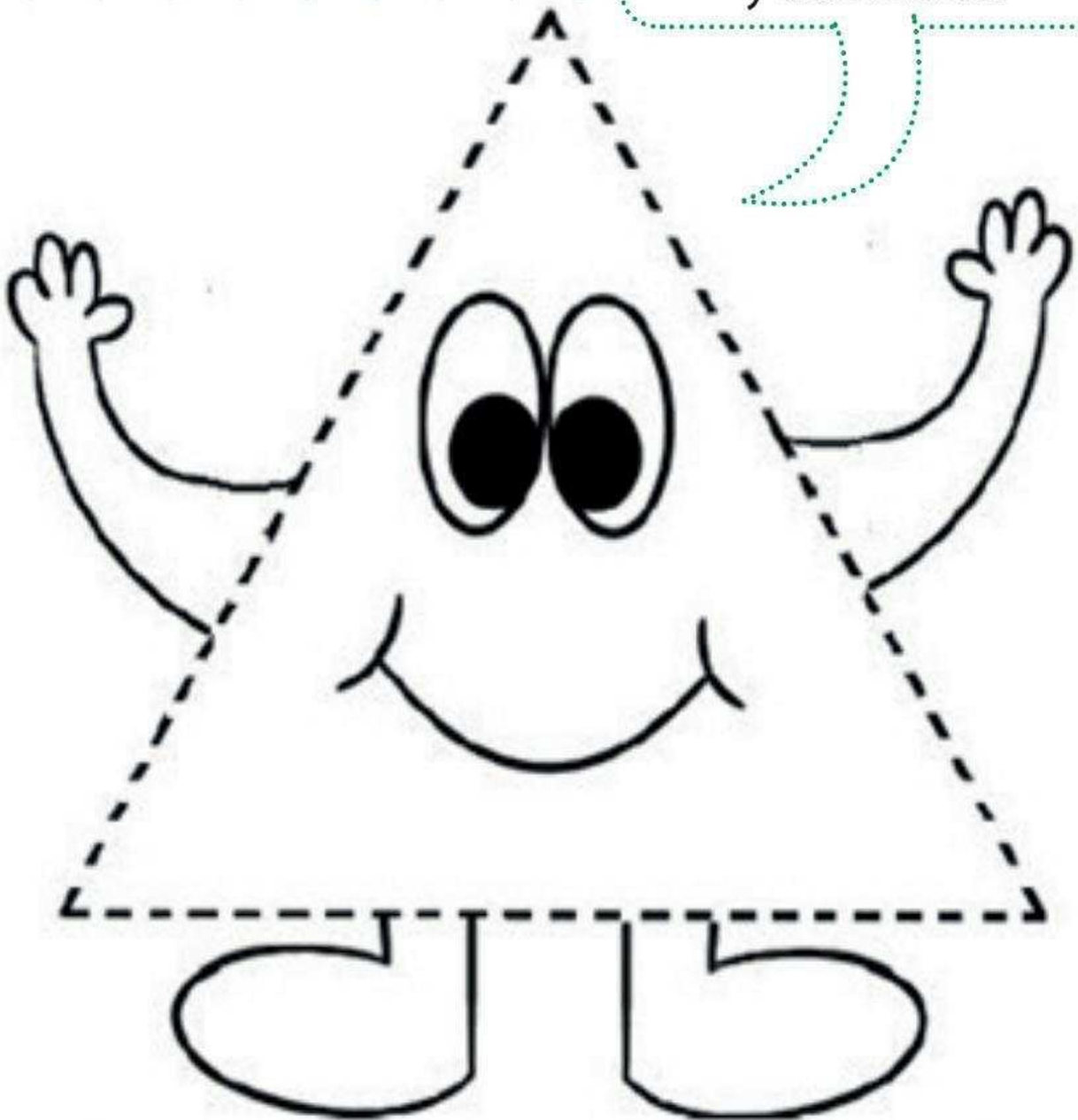

Repasa por los puntos del triángulo con plumón de colores y colorea de amarillo.

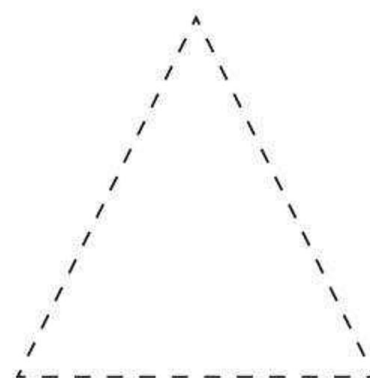
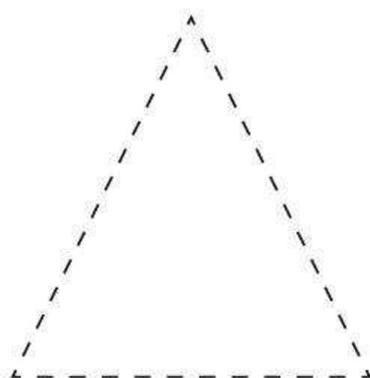
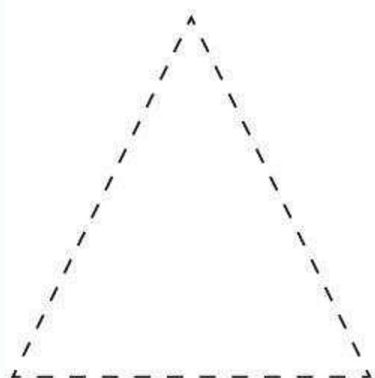
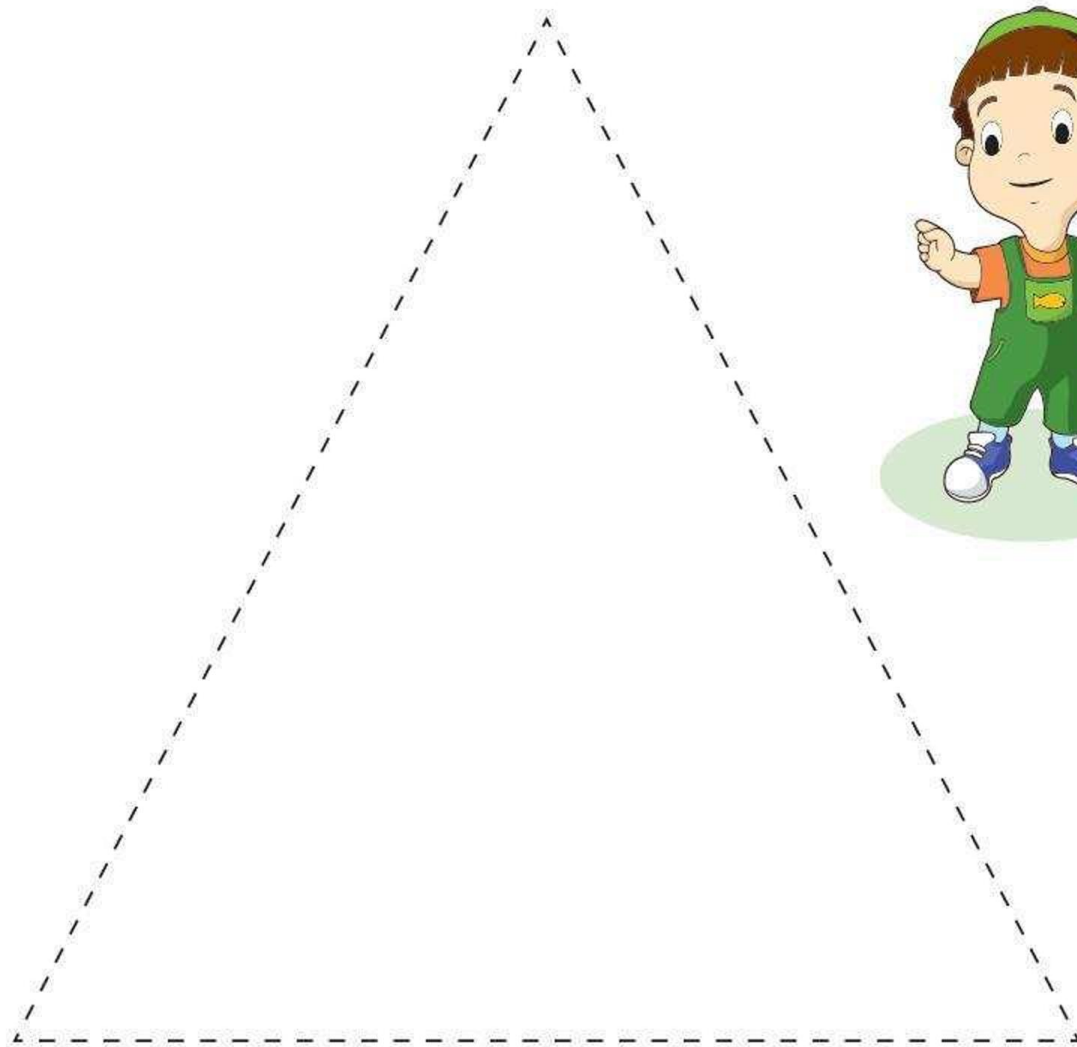

Largo - Corto

Colorea el tren corto de rojo y el largo de azul.

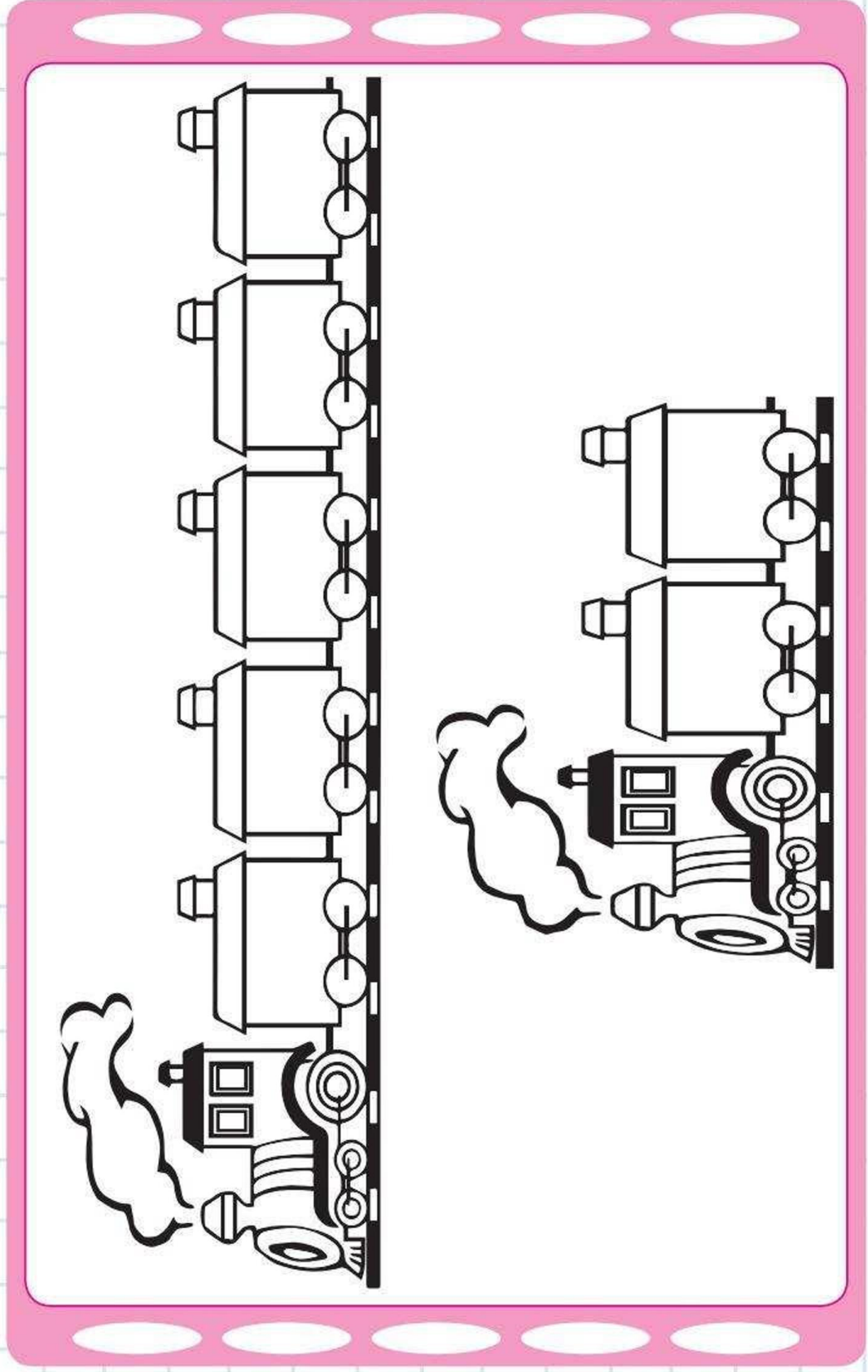



Con tu dedo índice colorea con t mpera el gusano largo.

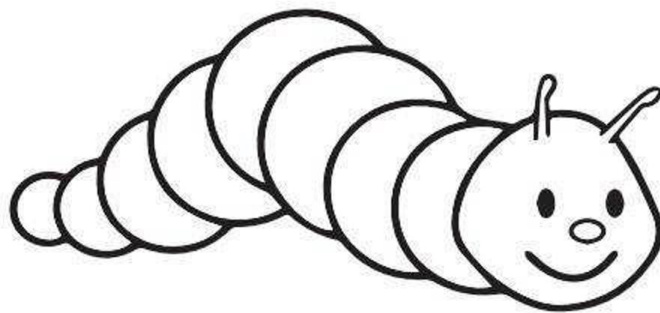
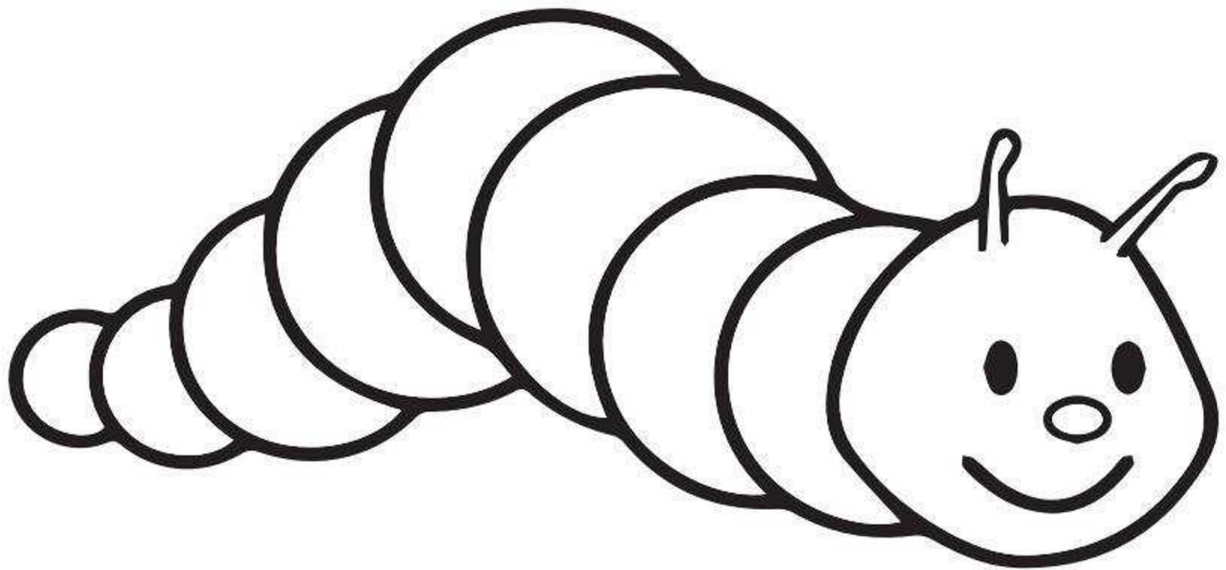



Pega lentejitas por las líneas del número 2.

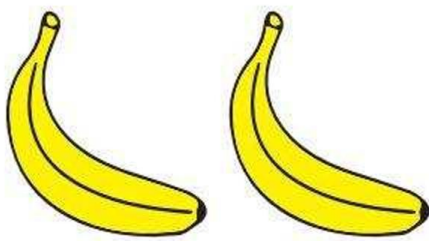
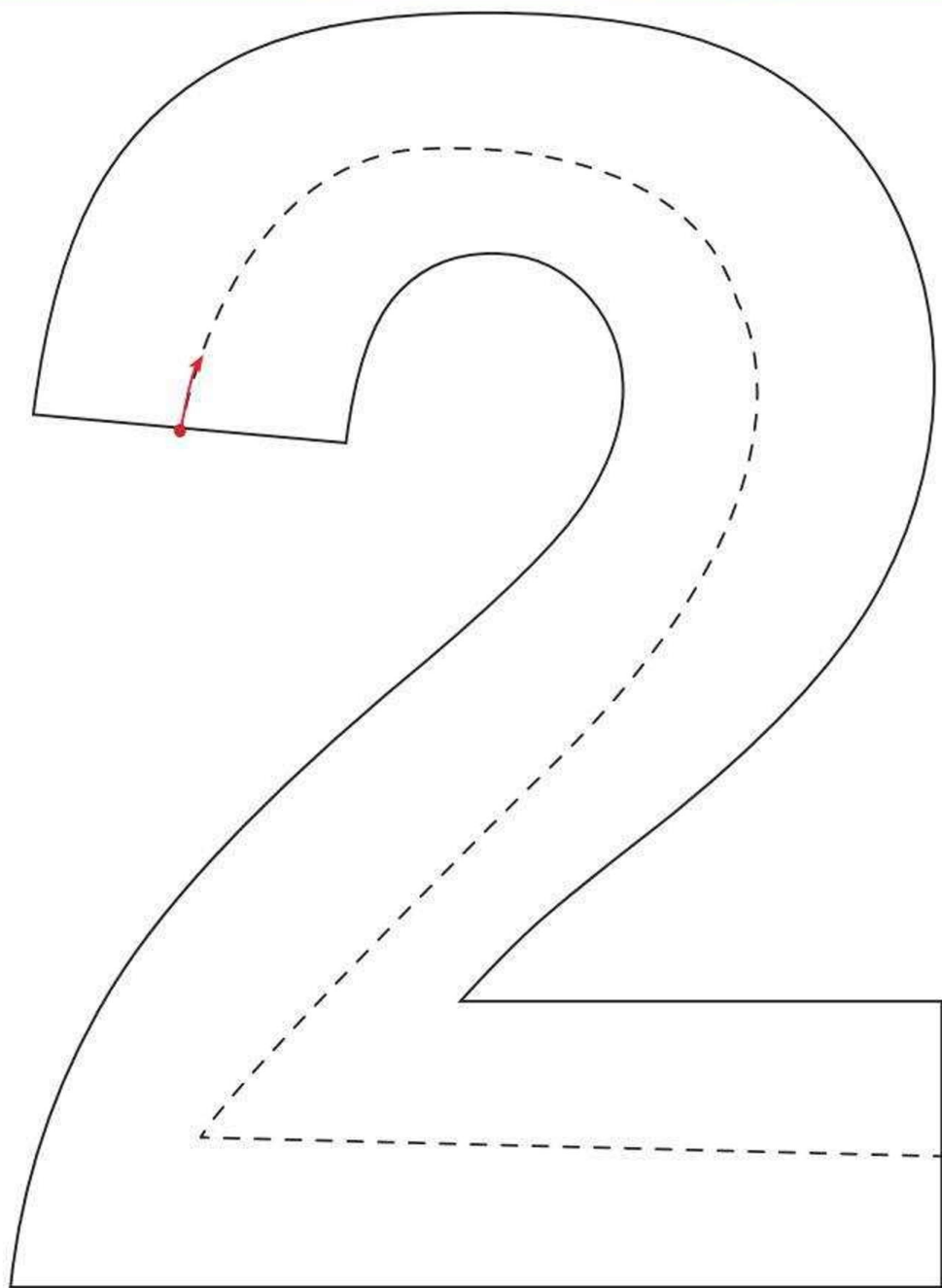

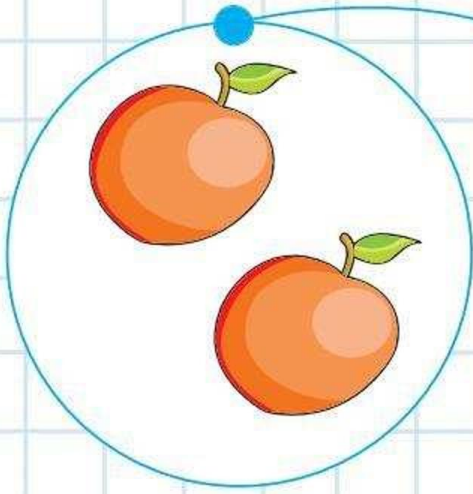

2



Colorea los conjuntos que tengan dos elementos.

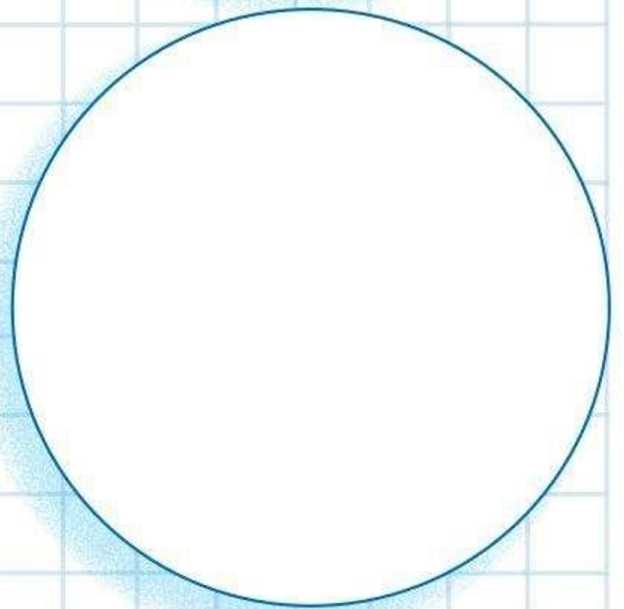
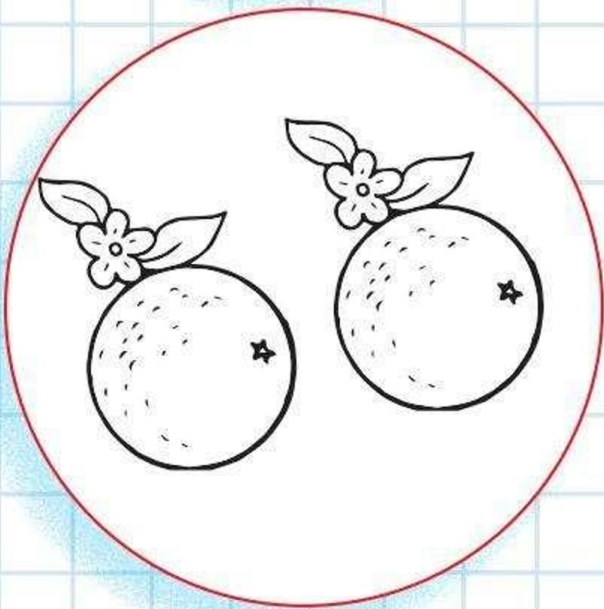
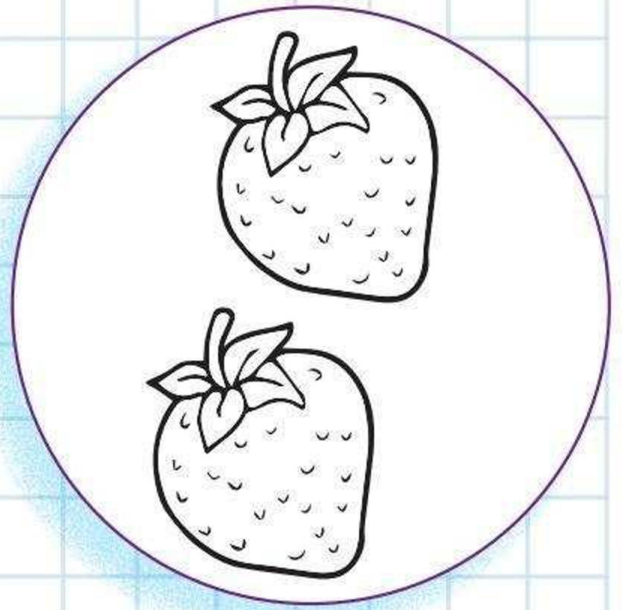
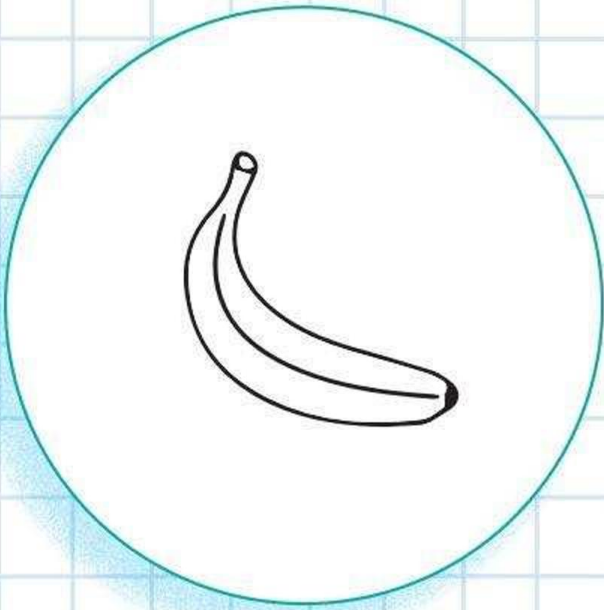



Embolilla papel por las líneas del número 3 y colorea los lápiz.

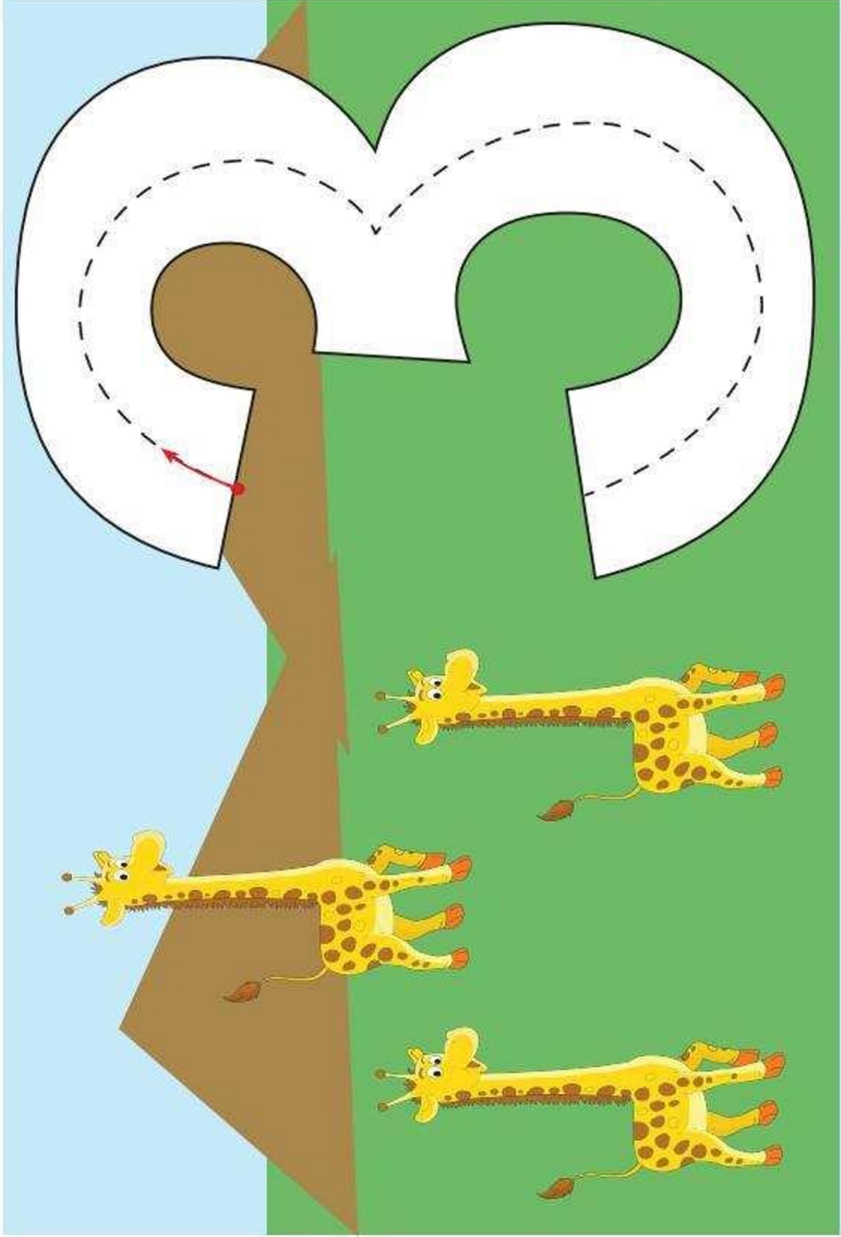
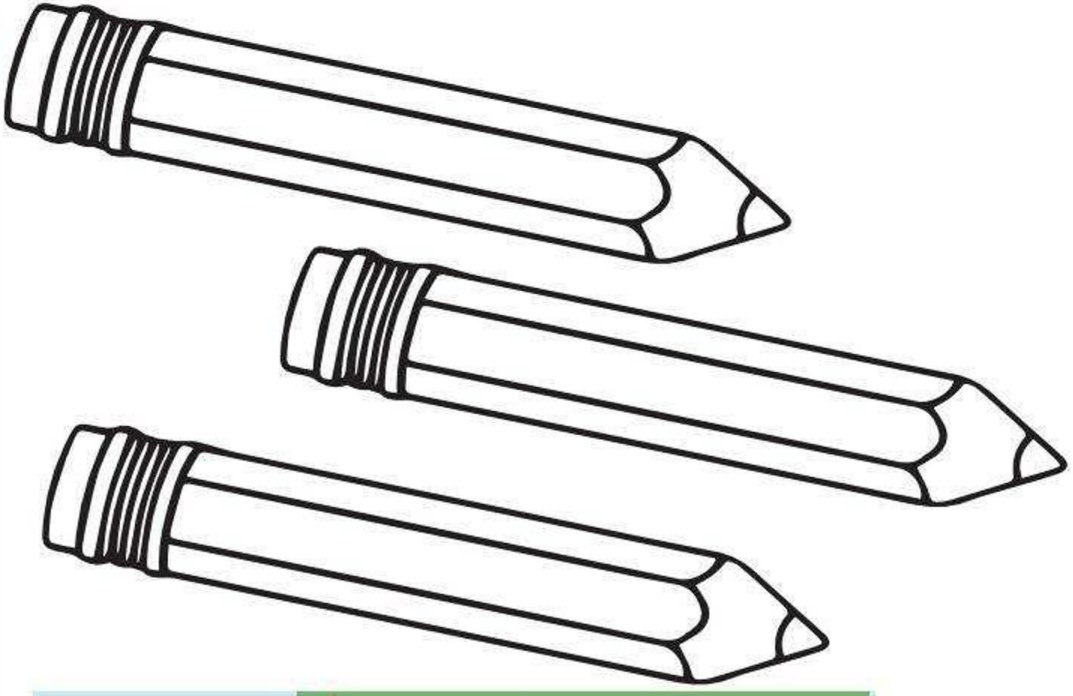



Repasa con plumón el número 3 y colorea contando los patos.

3





Colorea según indica los números.

1

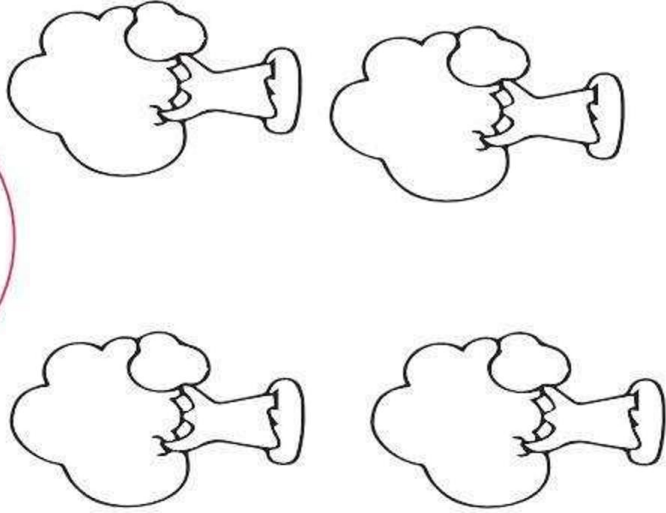

2

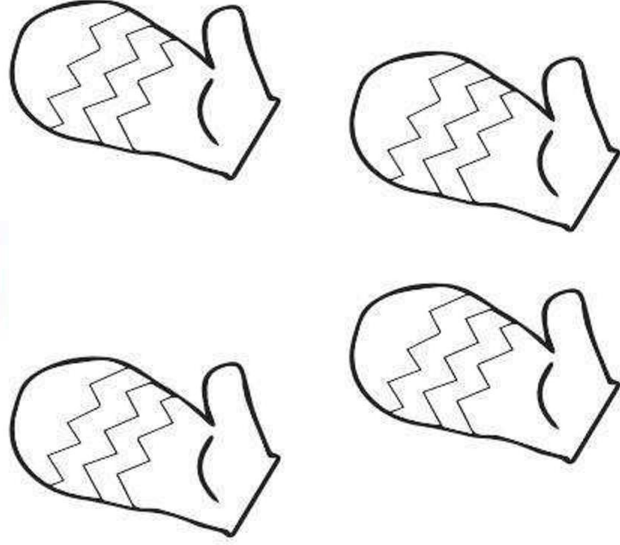

3

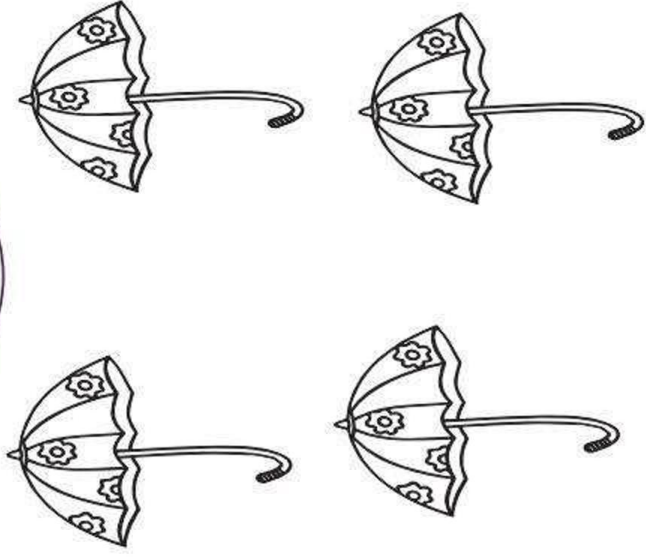

Lleno - Vacío

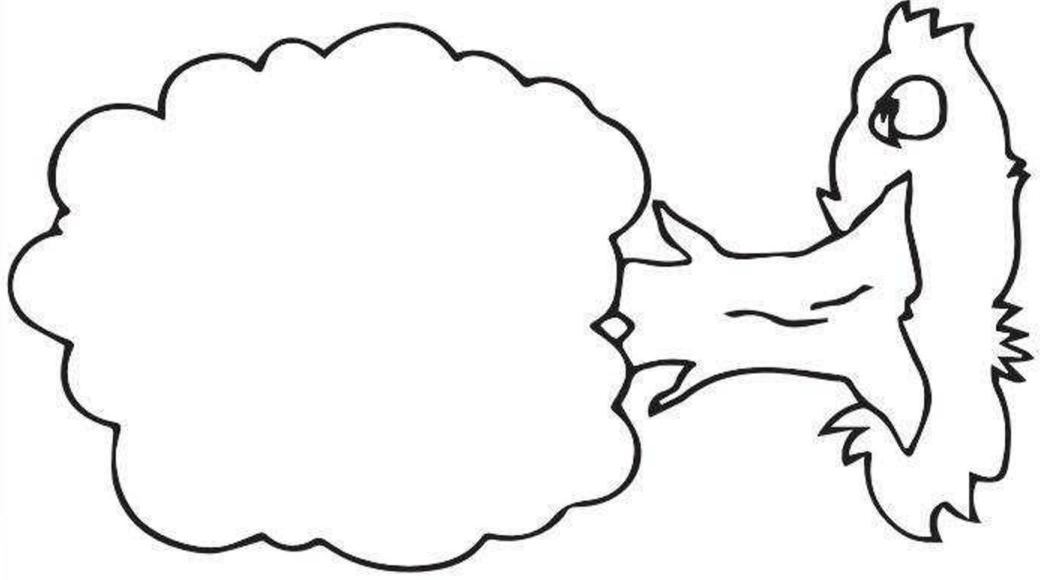
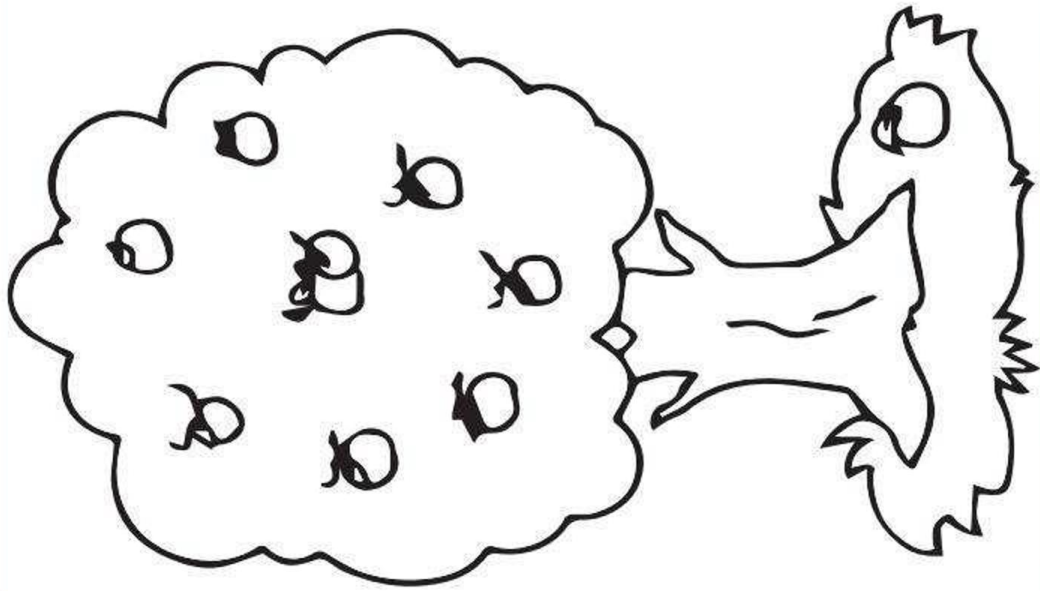

Colorea el árbol que está lleno de manzanas.



Pega serpentina al borde de la pecera llena.

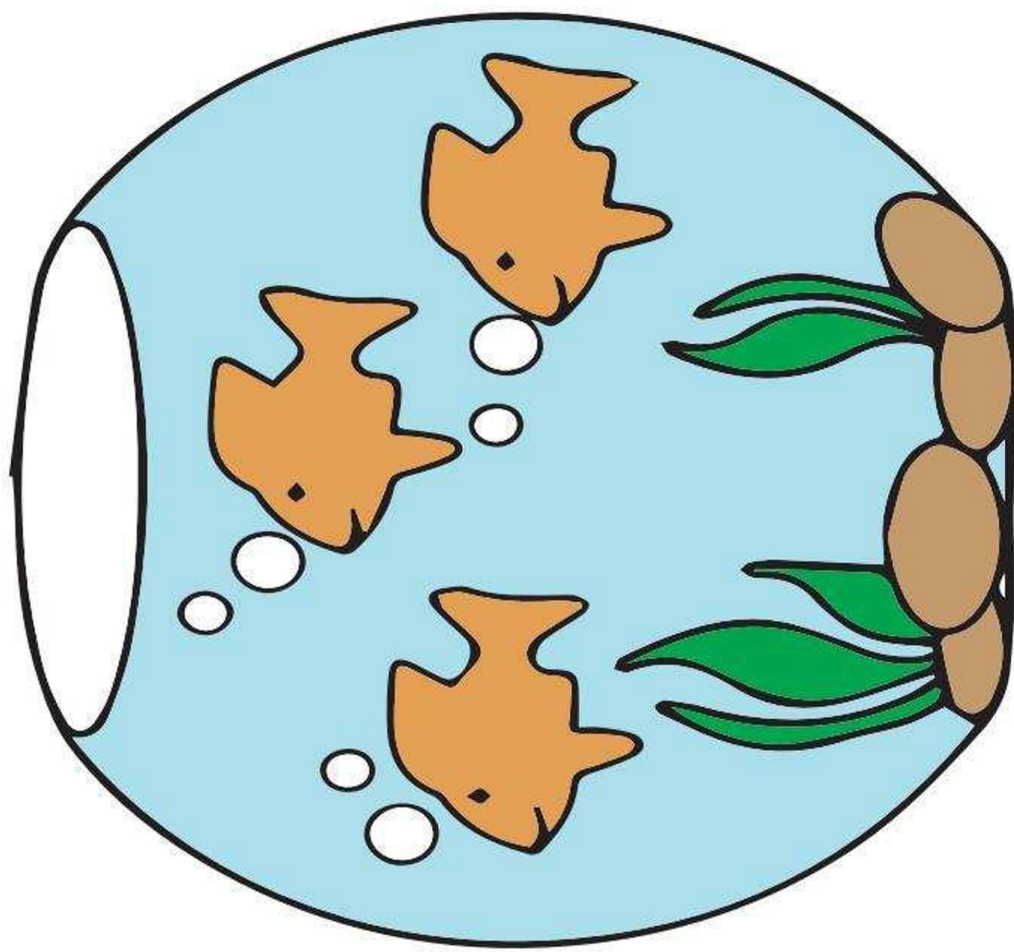
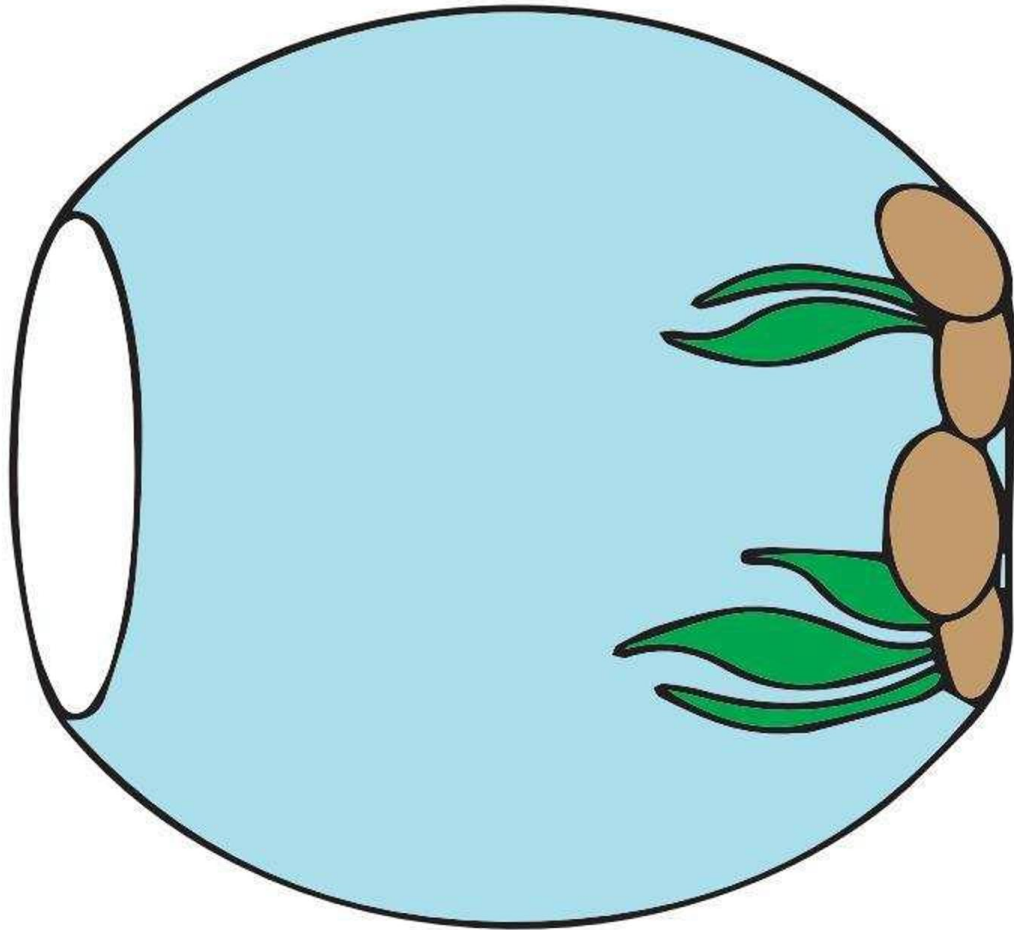



Completando las figuras. Observa y completa lo que falta al payaso.

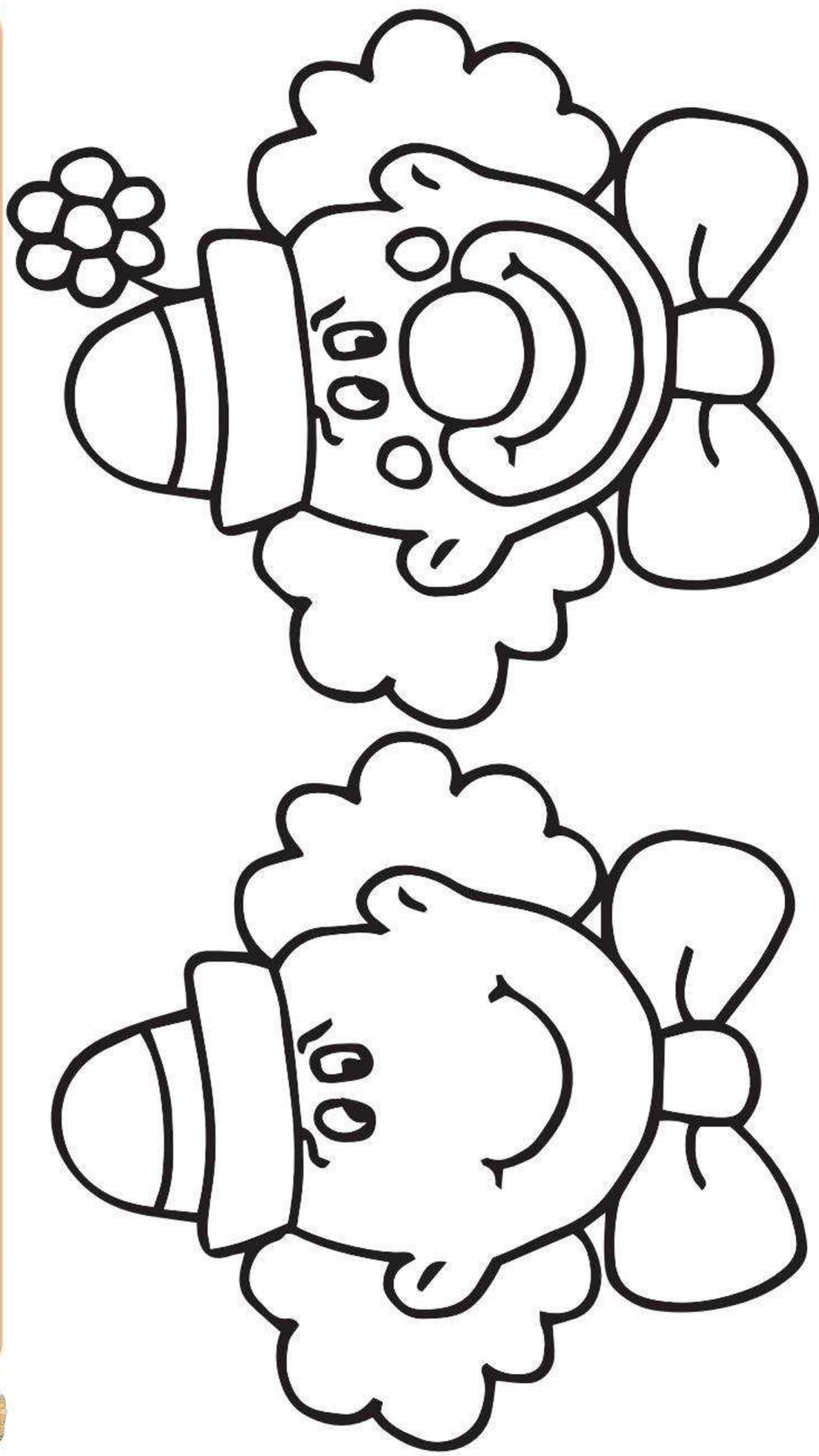

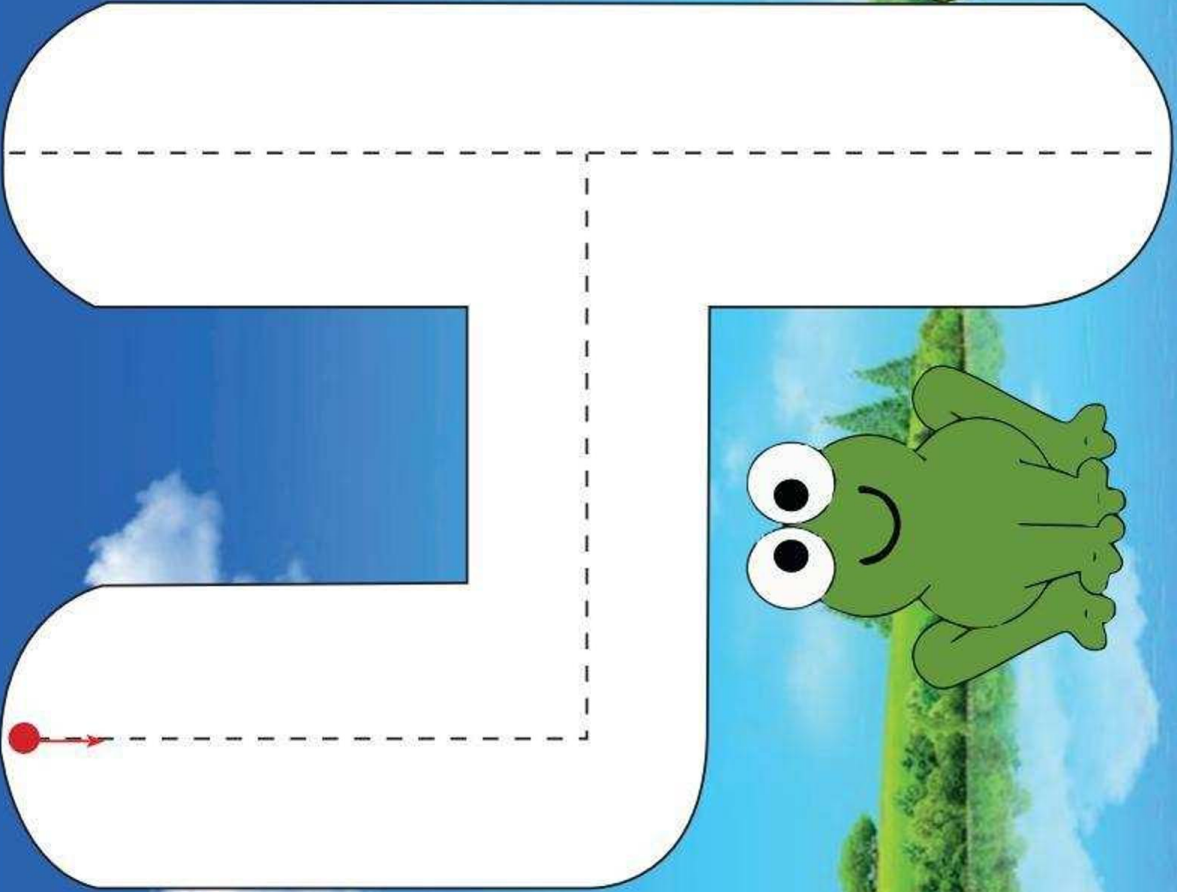

Repasa con t mpera el n mero 4.

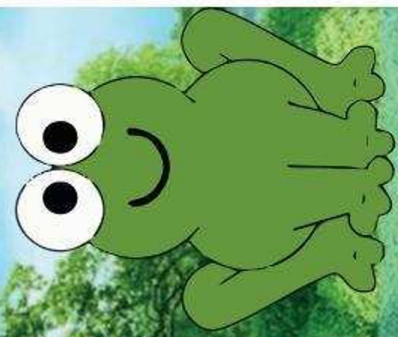
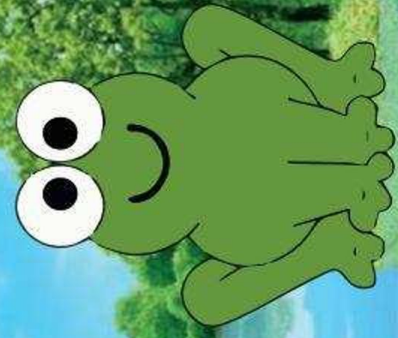
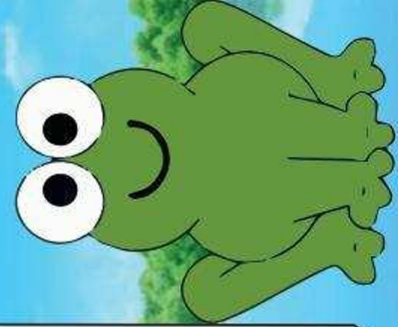
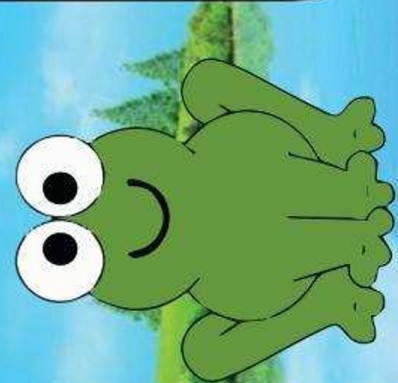



Repasa el número y con plumón.

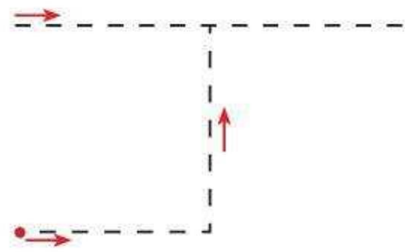
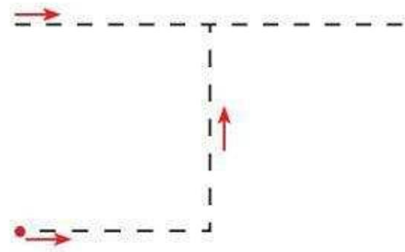
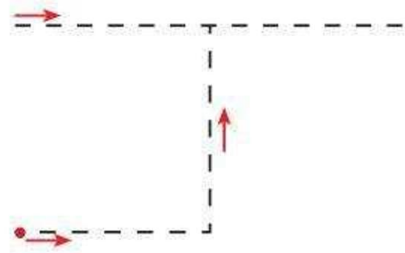
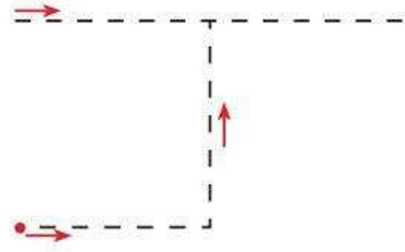
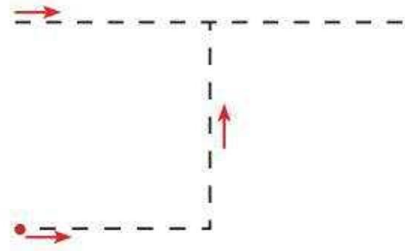
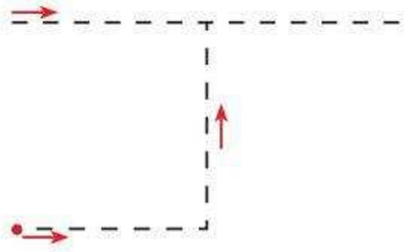
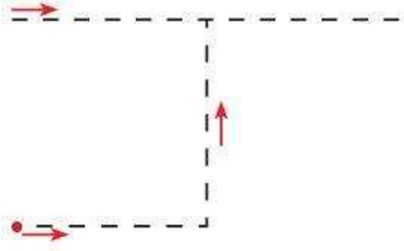
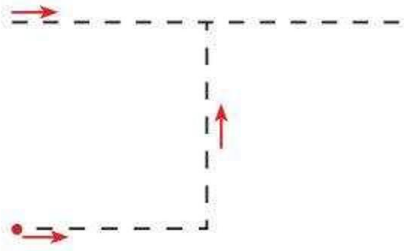
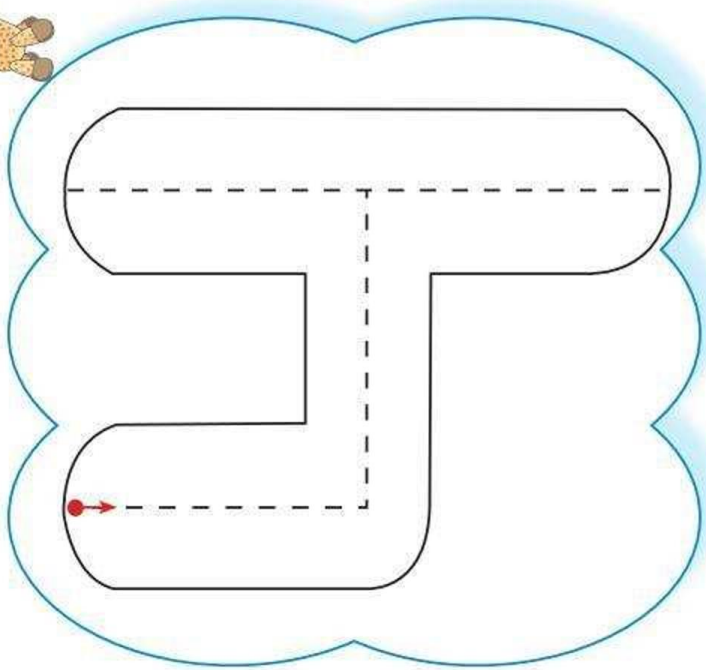

Cerca = Lejos

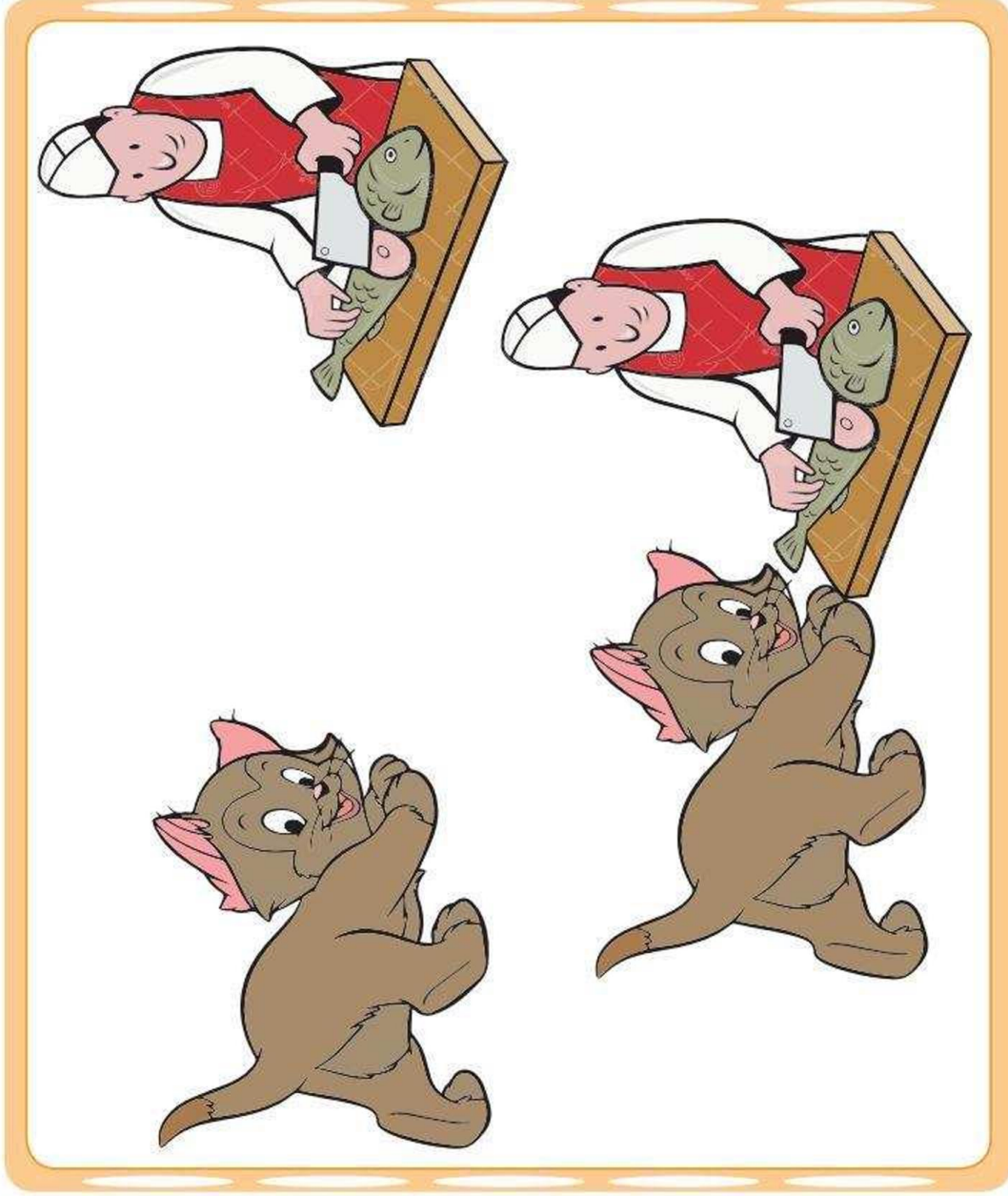
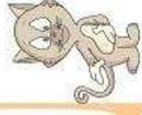

- ◆ Encierra al gato que tiene el pescado cerca.
- ◆ Marca (X) al gato que tiene lejos el pescado.

Números del 1 = 4



Reposa cada número y pinta las imágenes contando.

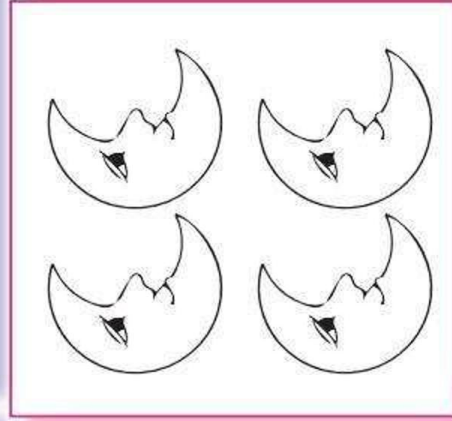
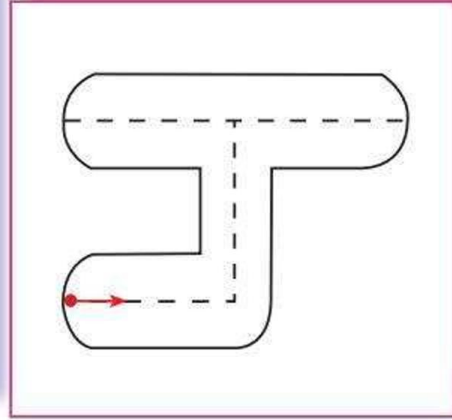
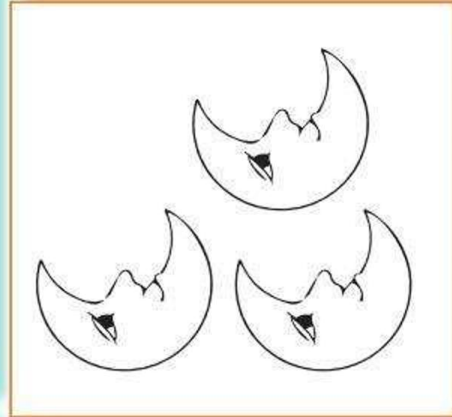
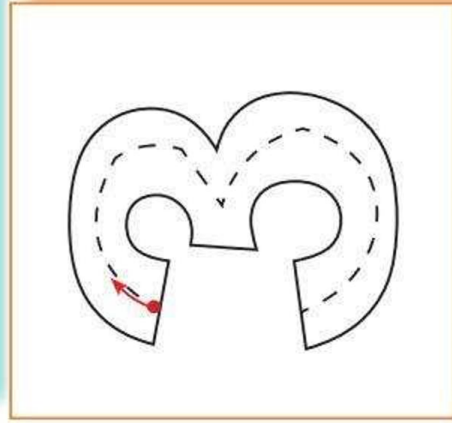
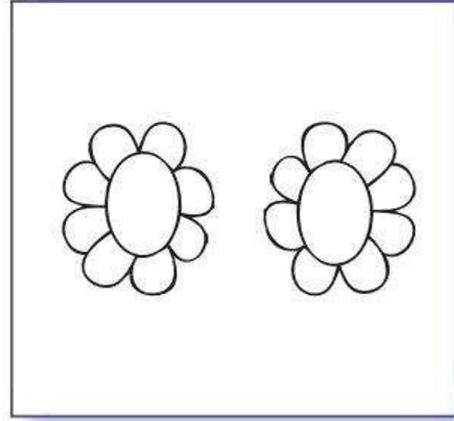
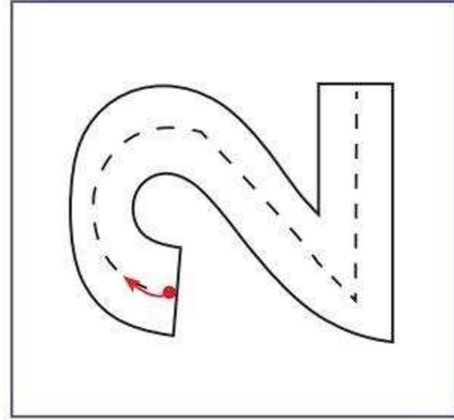
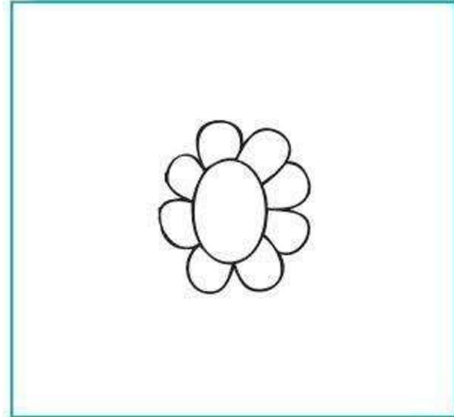
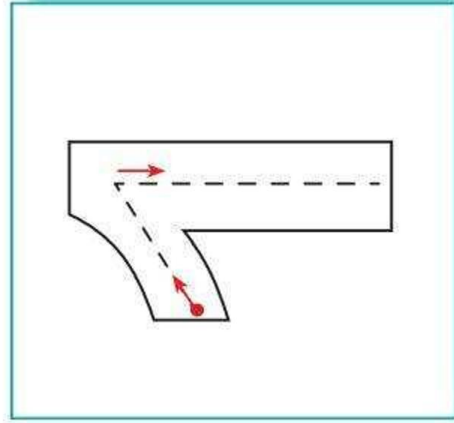

Grueso - Delgado



- ◆ Colorea el lápiz grueso de color azul.
- ◆ Pinta el lápiz delgado de color rojo.

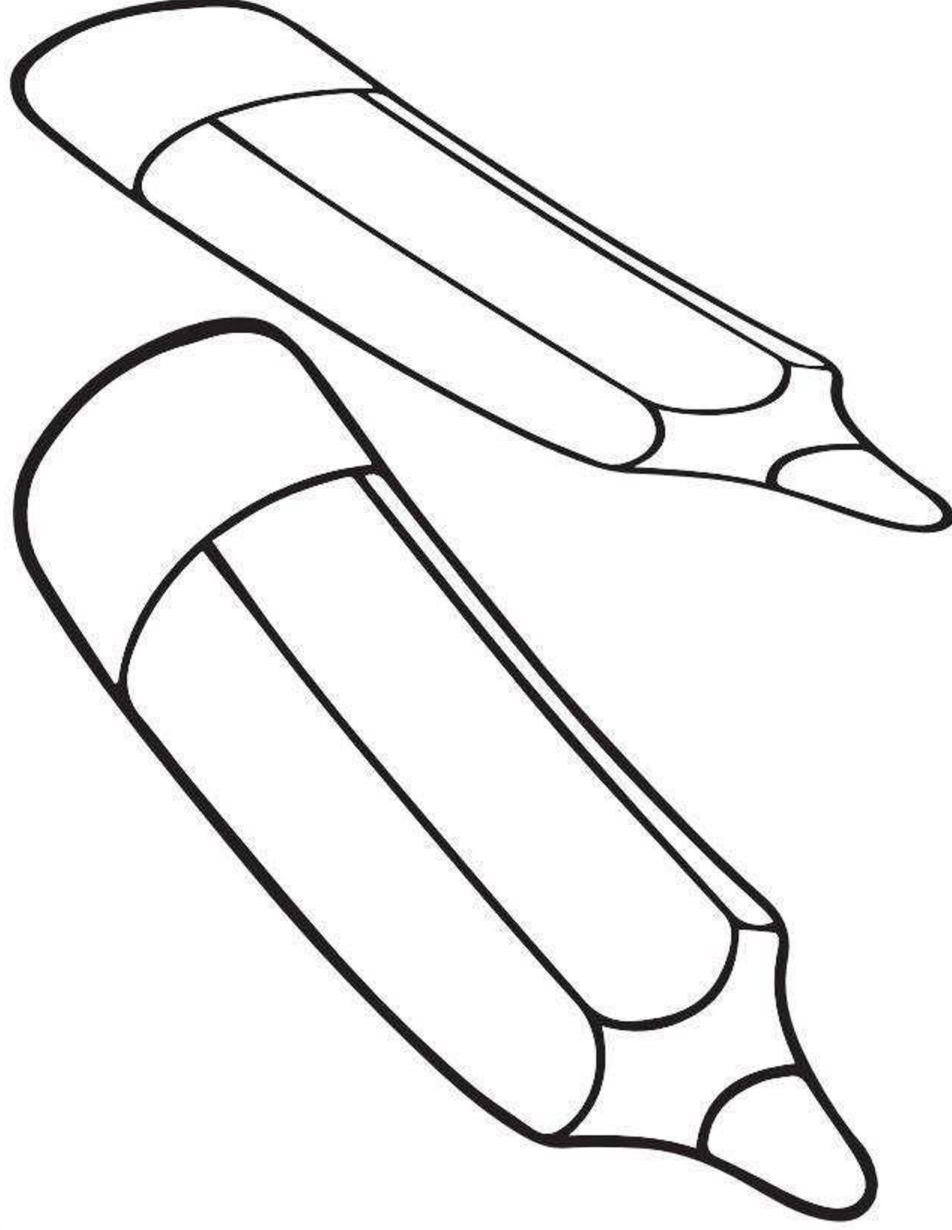

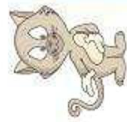

- ◆ Pega lana en el cabello del payasito grueso.
- ◆ Rasga papel en el sombrero del payasito delgado.

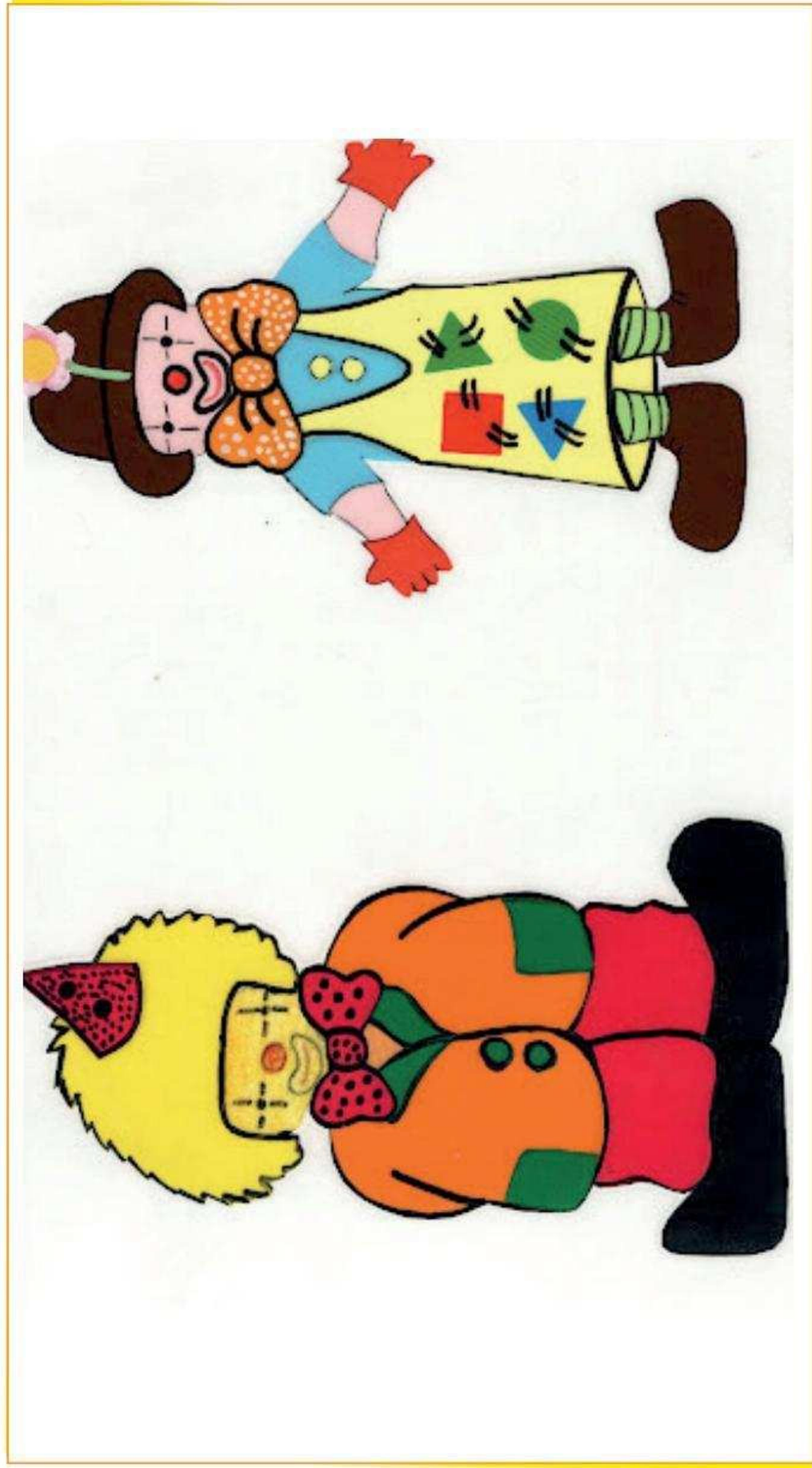



Embolilla papel en el número 5 y repasa los números.

Colorea cada carrito contando.



A large grey rectangular area containing a large dashed number 5 for tracing, five toy cars numbered 1 to 5, and a dashed number 5 for tracing.

A vertical strip containing five dotted number 5s for tracing.

Color negro

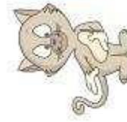
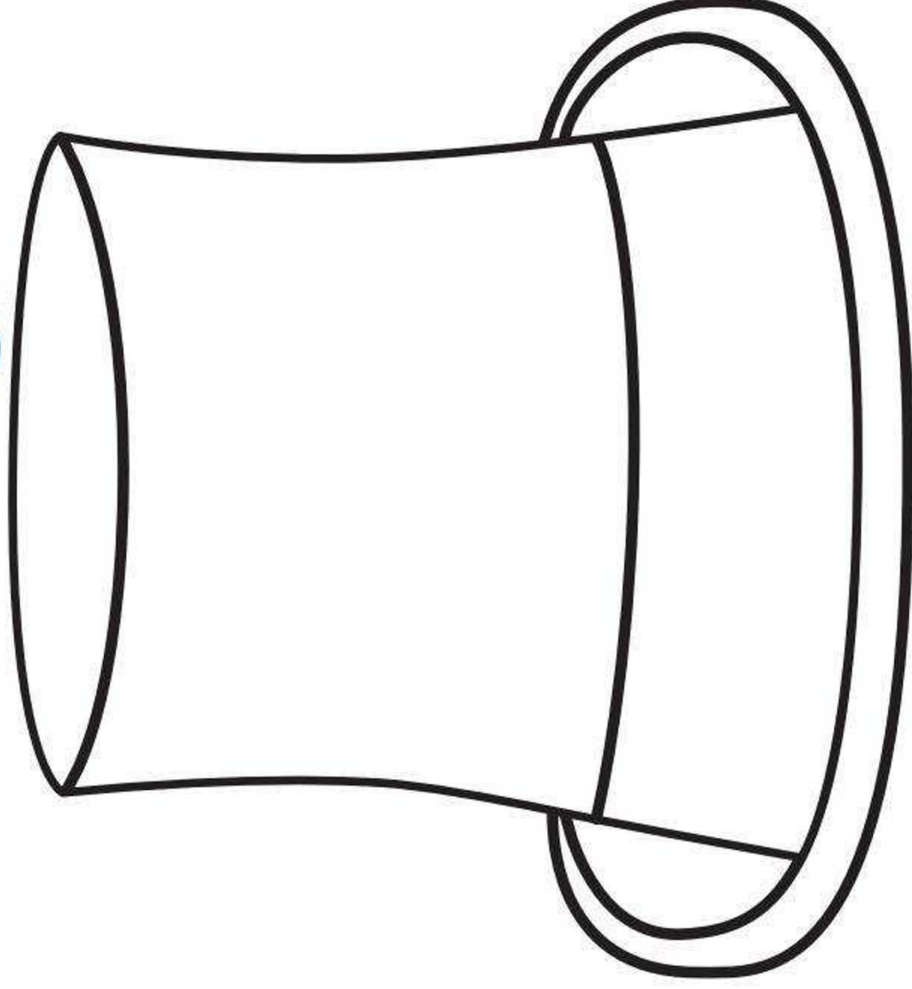

Pinta el sombrero de color negro.

Color negro

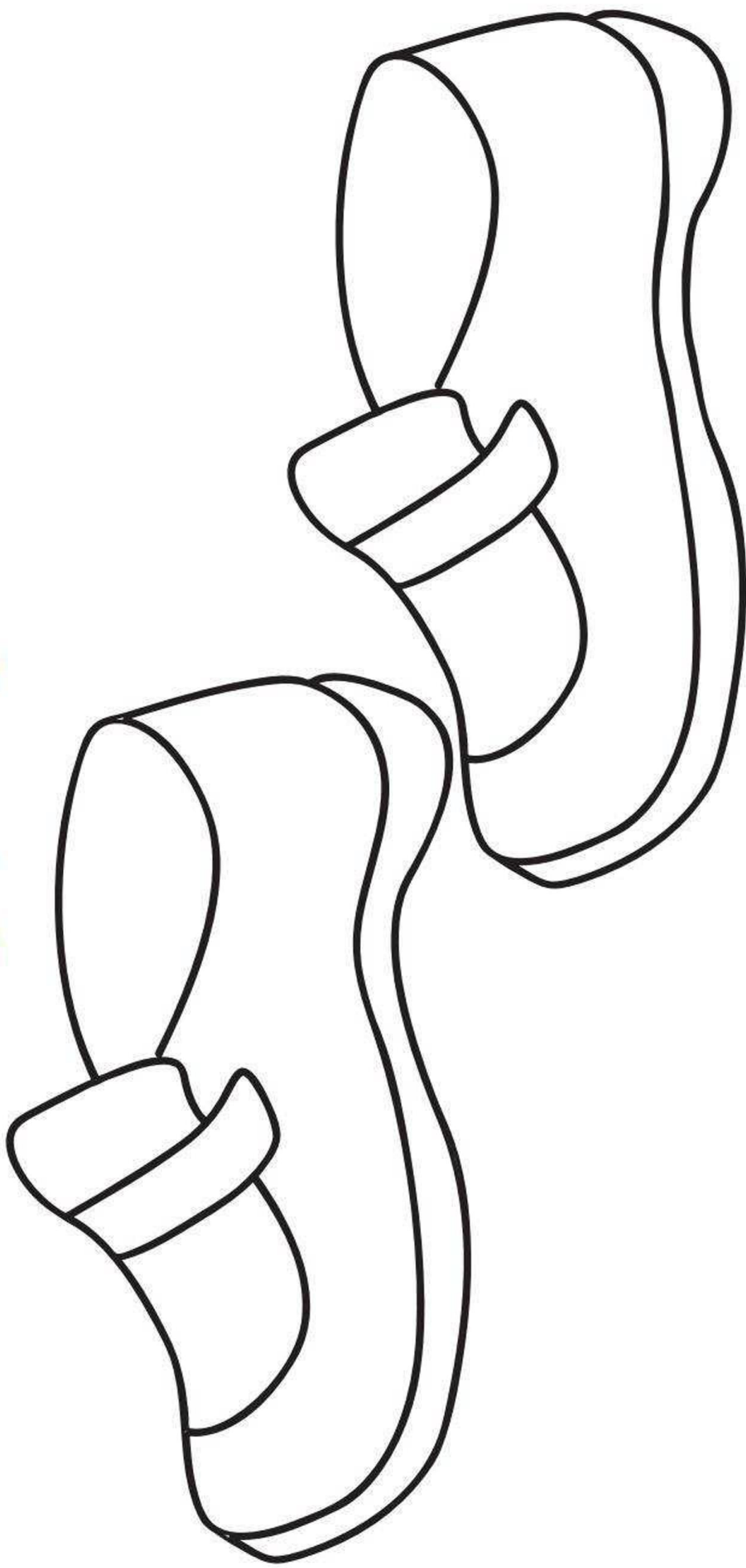

Pinta los zapatos de color negro.



Número 6

Pega lentejuelas en los puntos y colorea contando las fresas.

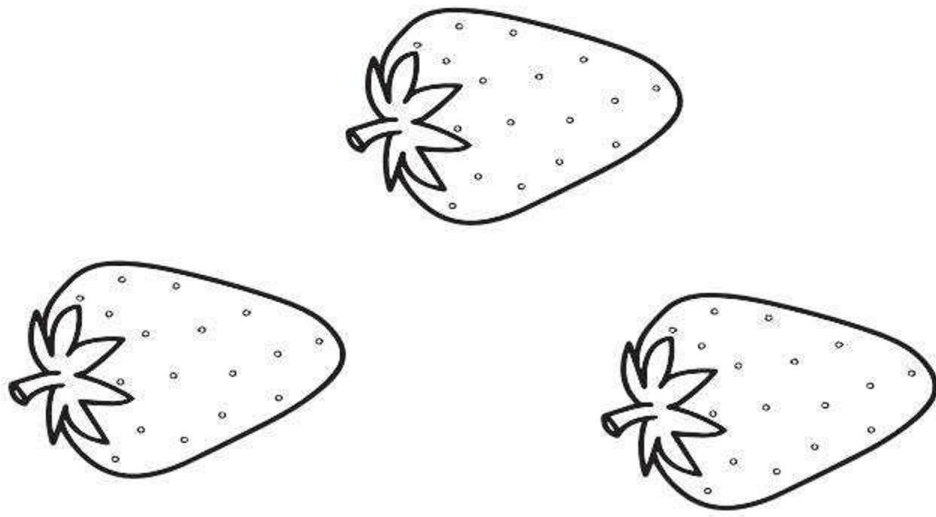
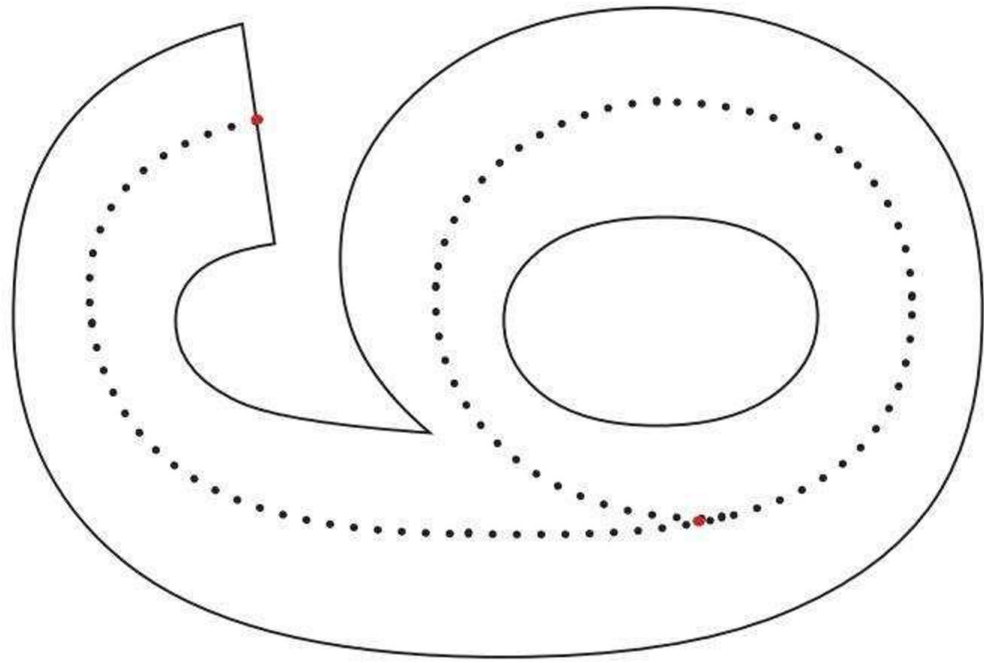
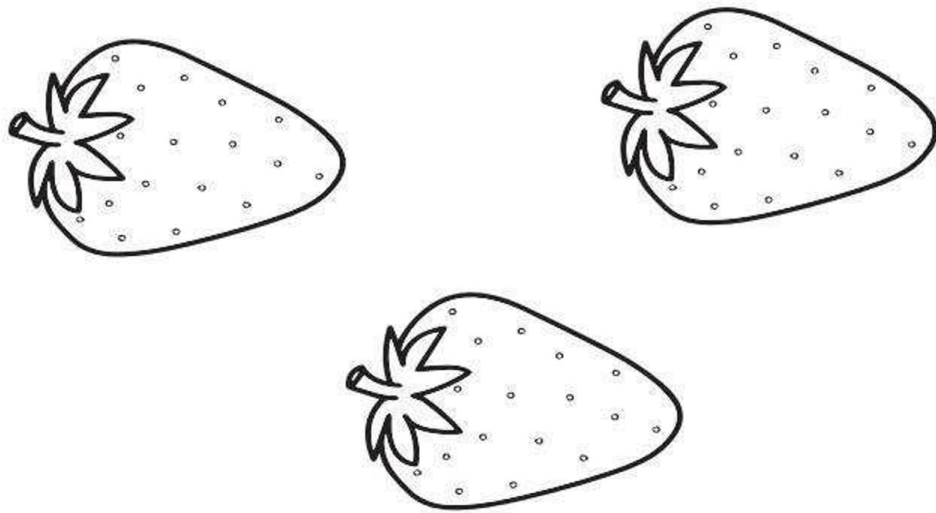



◆◆ Colorear seis autos.
◆◆ Repasa el número 6.

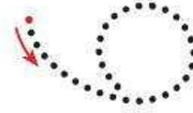
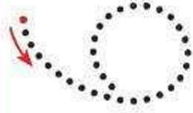
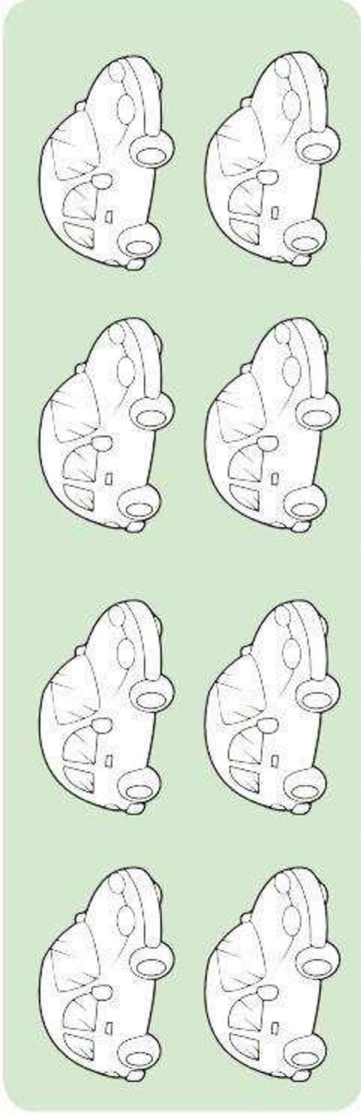

Primero = Último

Pinta al niño que está primero y marca (X) al niño que está último.

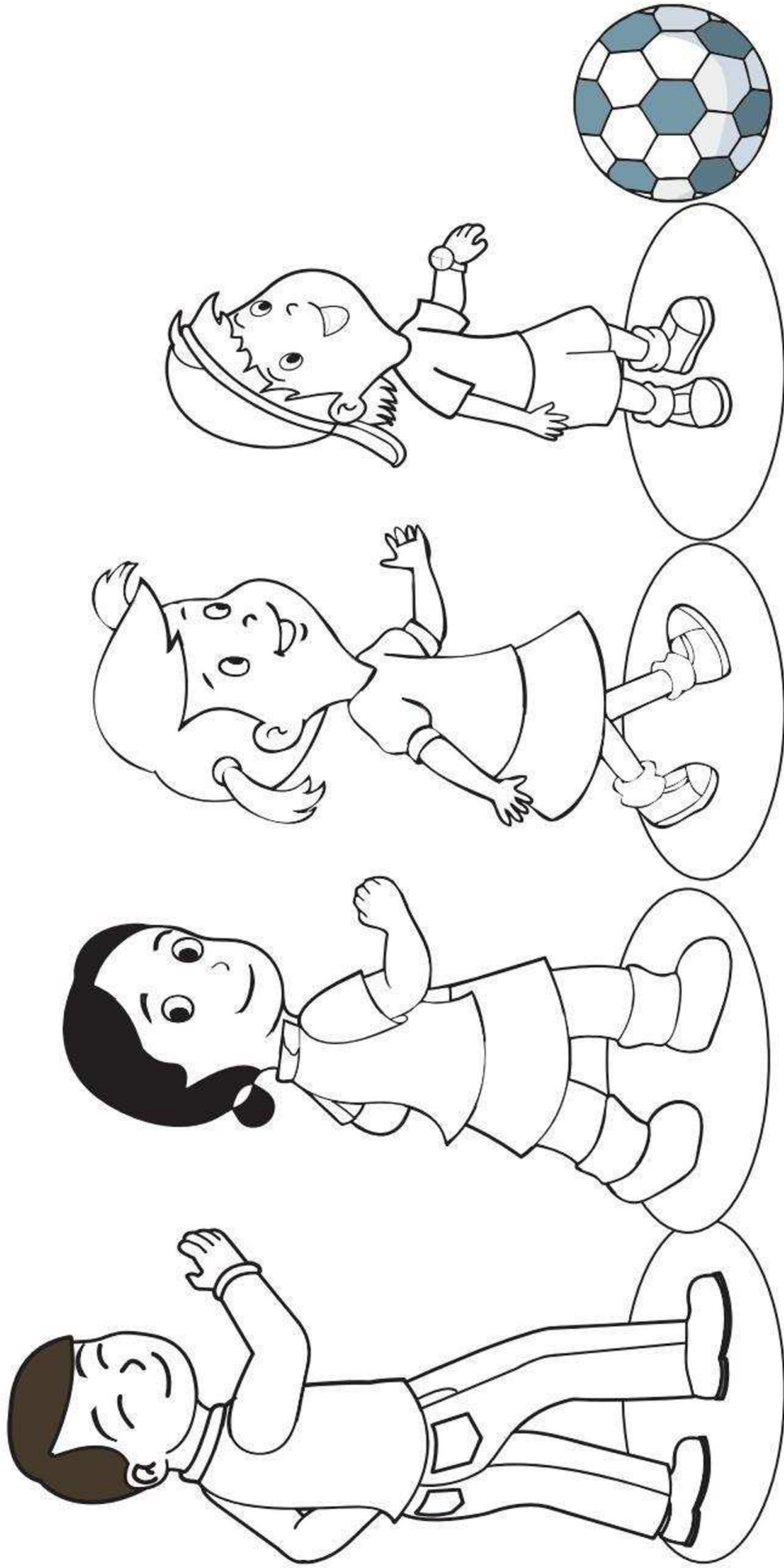

Ordinales

Colorea al tercer niño de la fila.

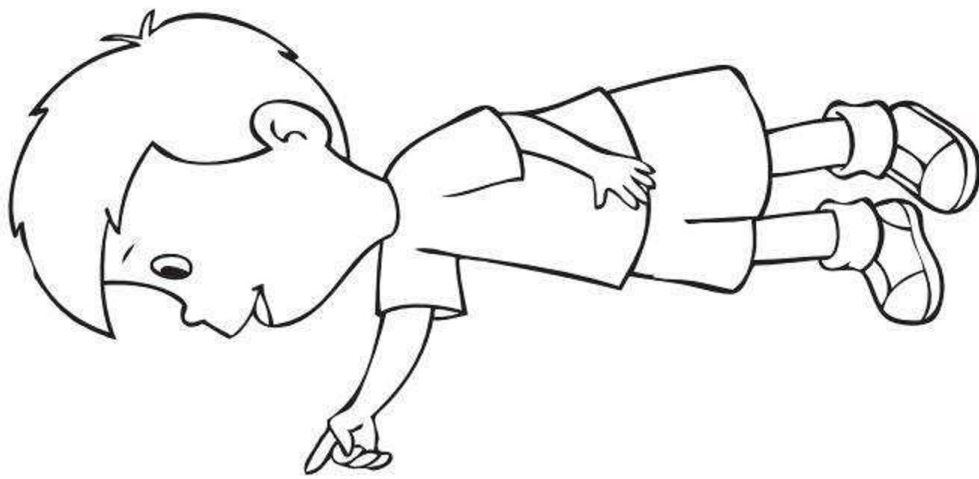
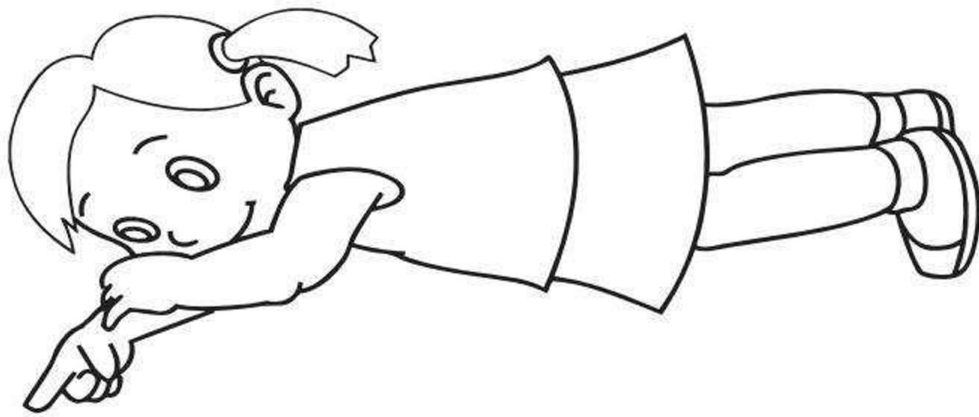
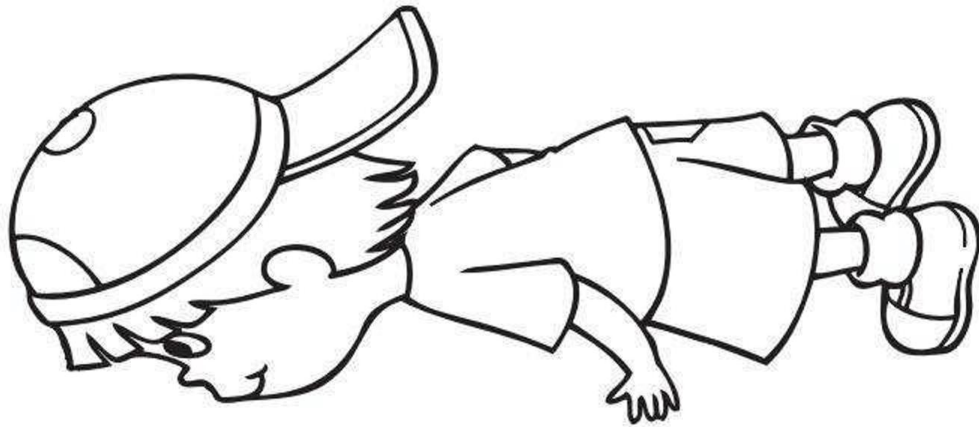
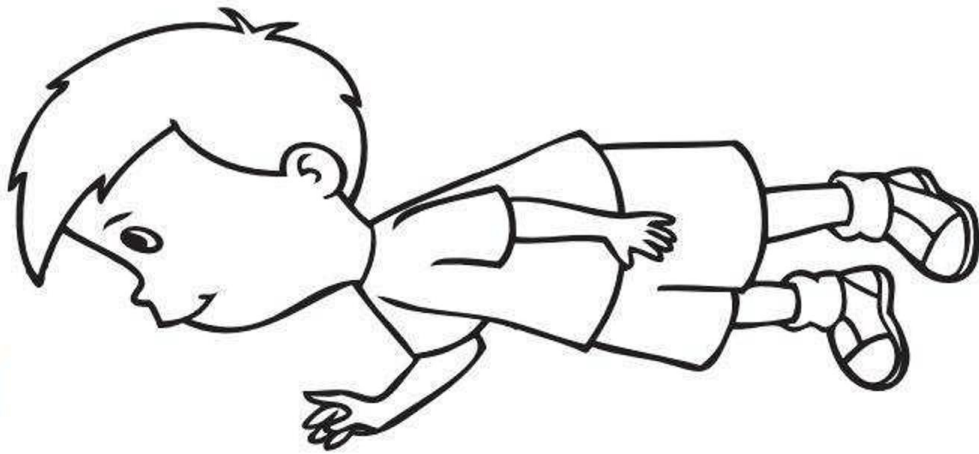

Verde

Con tu dedo índice pinta con tempera verde la mancha.

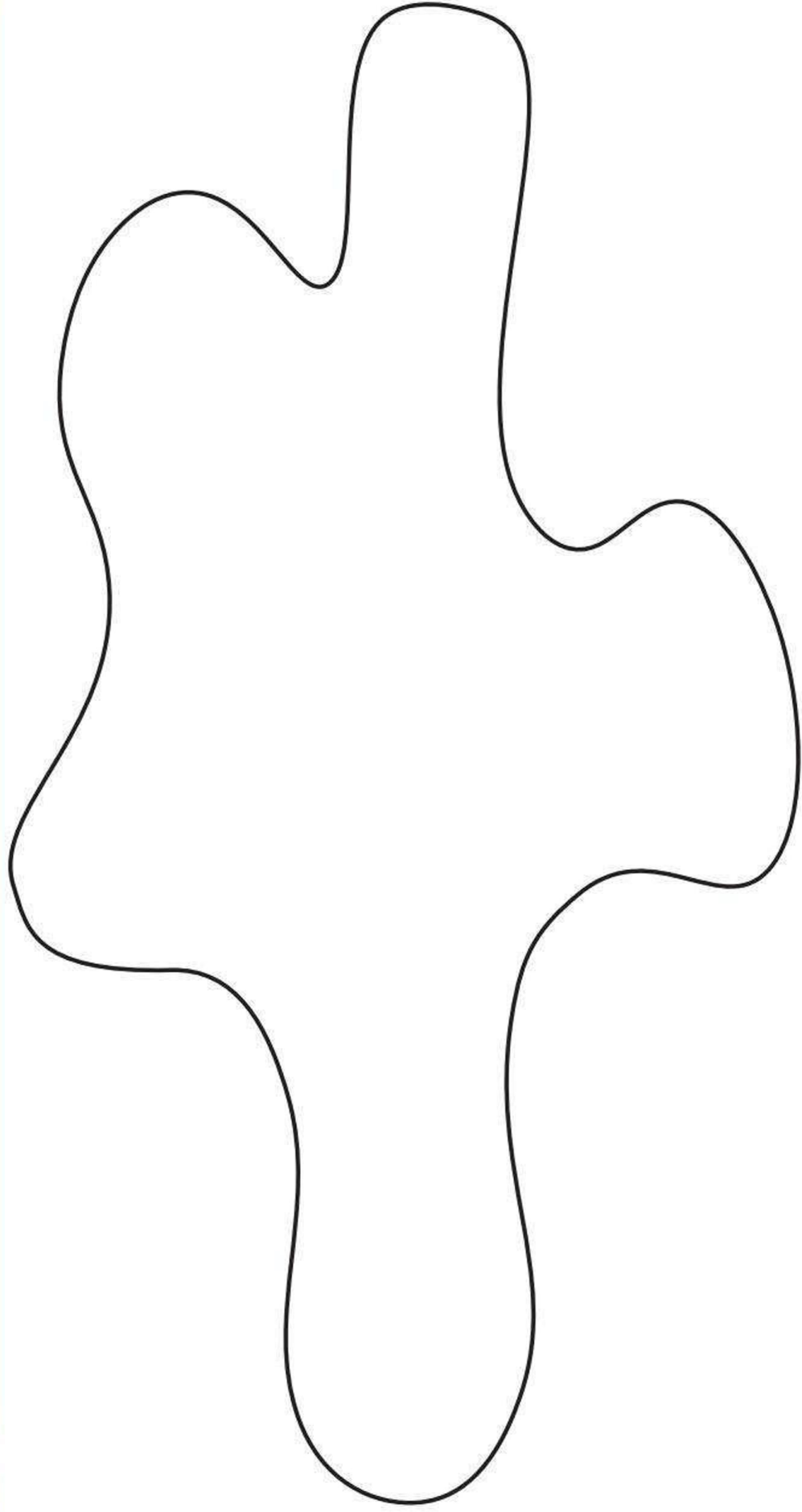

Número 7



Esparce plastilina por los puntos del número 7 y pinta los martillos.

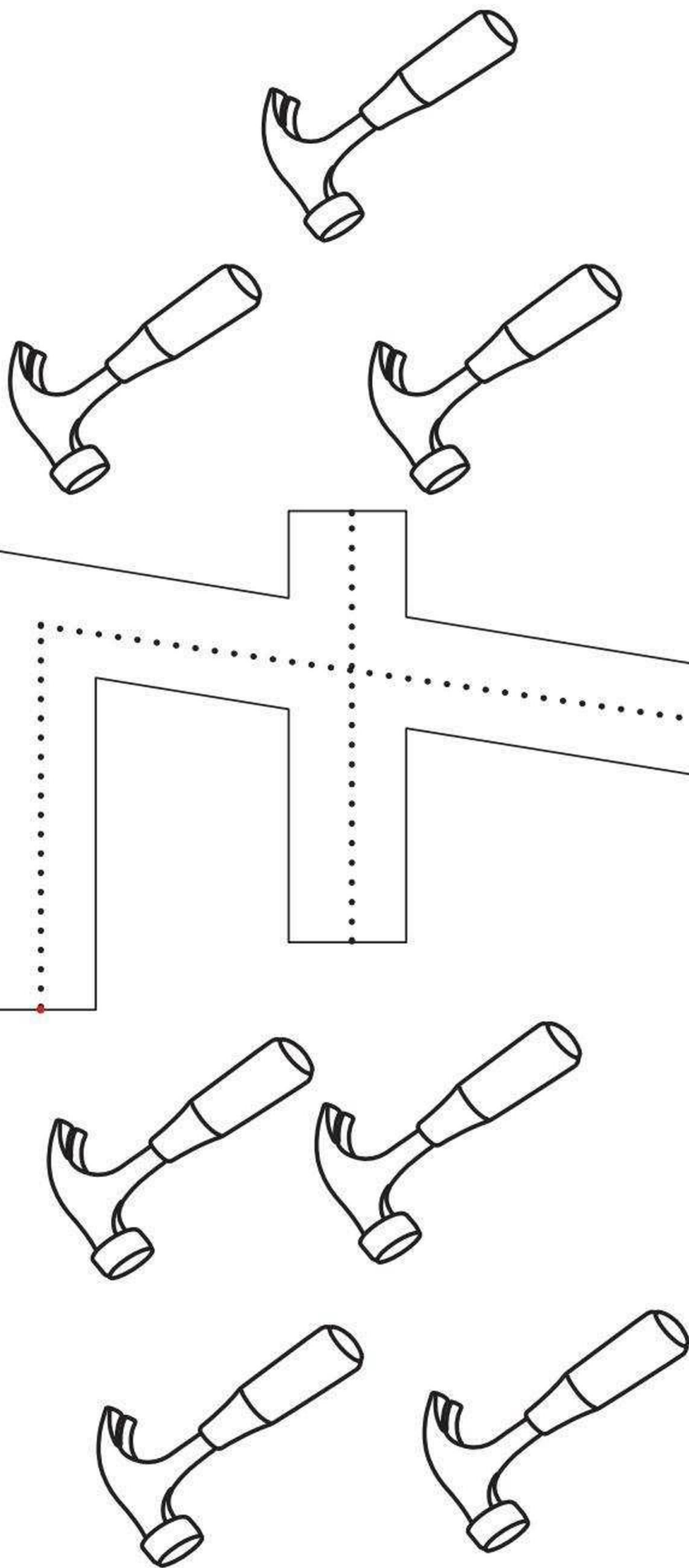
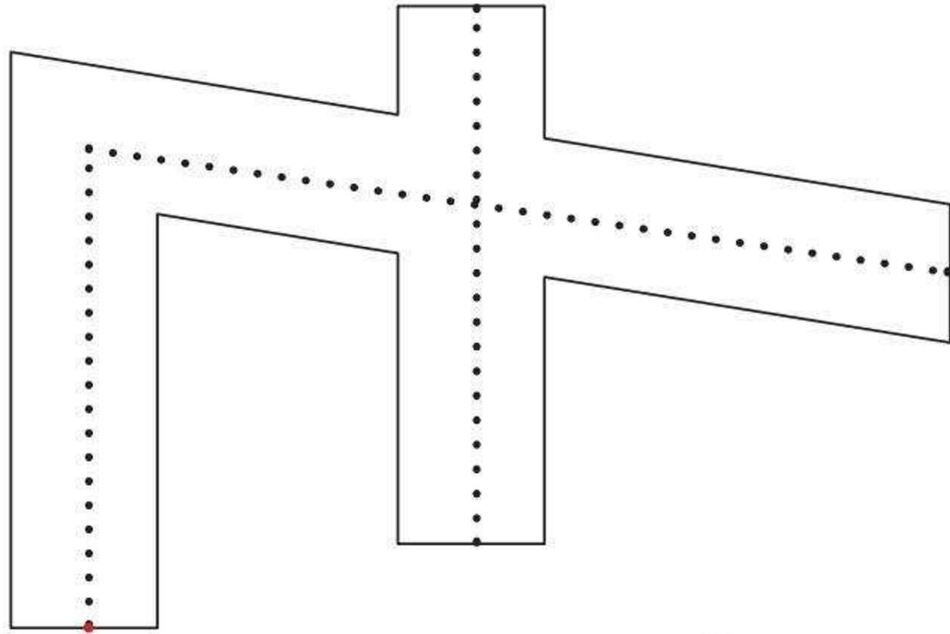

Colorea y repasa por los puntos.

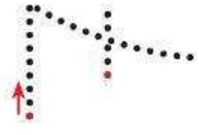
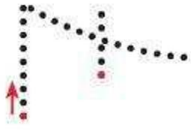
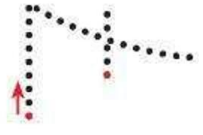
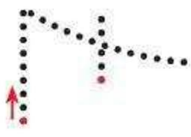
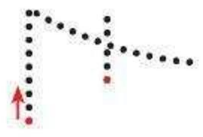
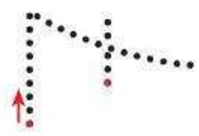
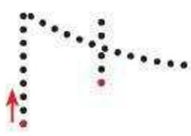
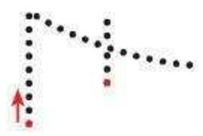
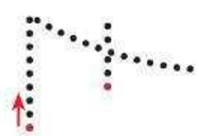
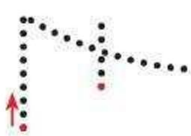
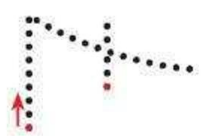
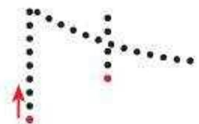
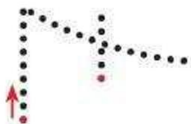
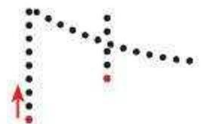
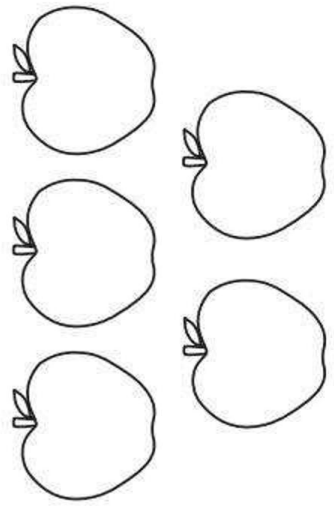
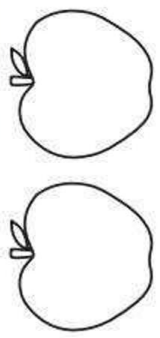
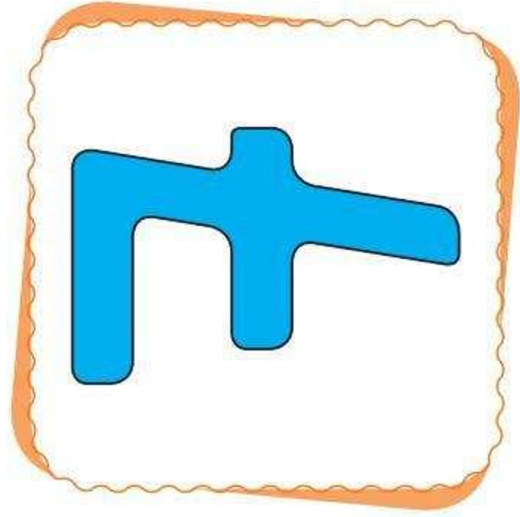



Colorea las prendas de invierno según el número.

2

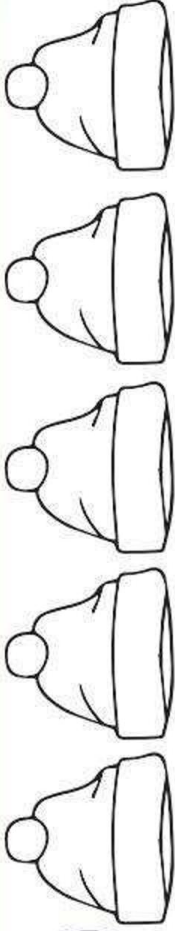

1

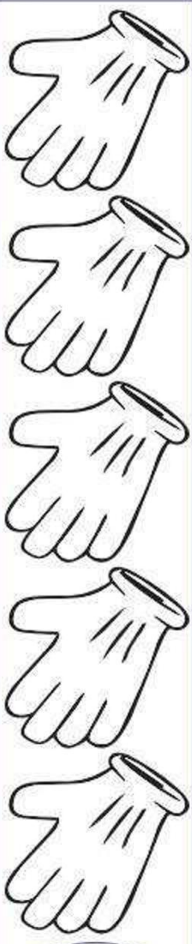

3



5



4

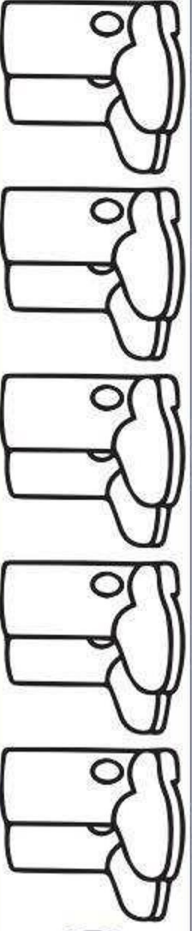

Relación numeral = cantidad



Cuenta los globos que tengan los ositos y únelos con el número que le corresponda.

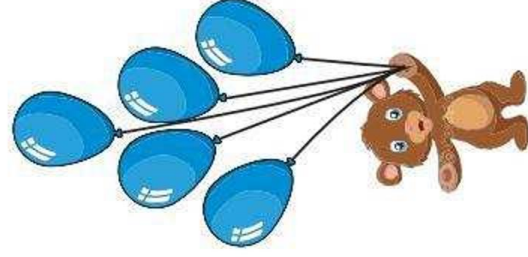
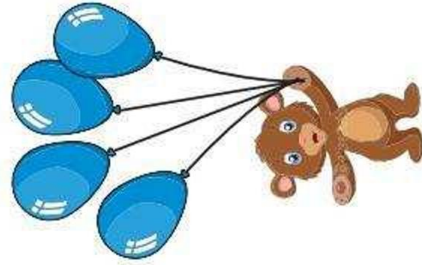
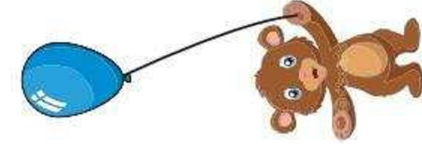
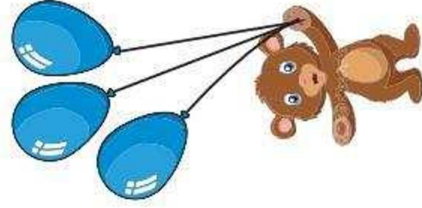
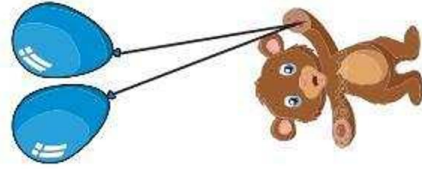
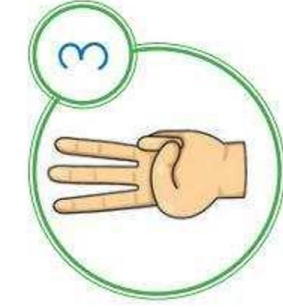
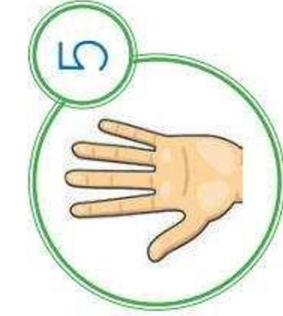
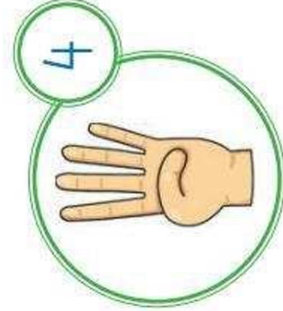
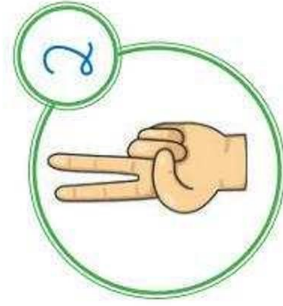
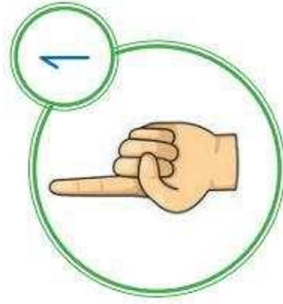

Secuencia de colores



Dibuja y sigue la secuencia según el color.

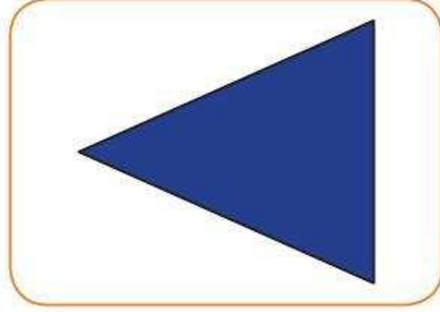
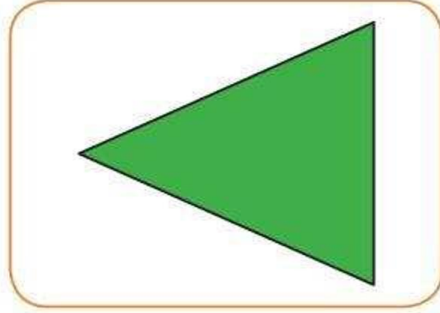
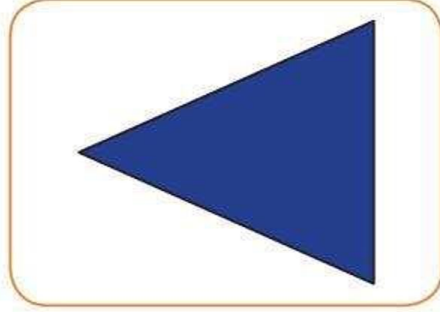
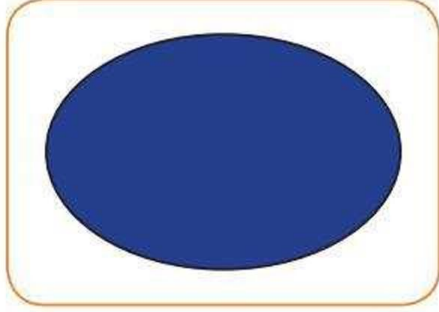
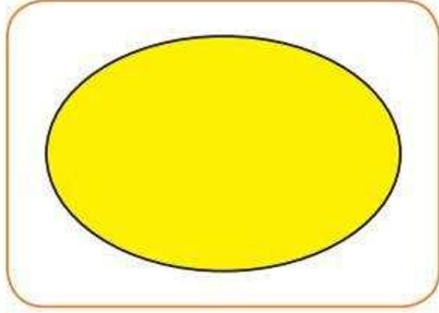
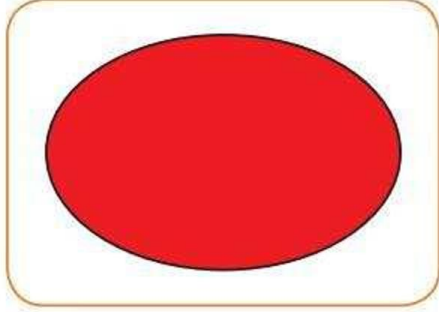

Número 8

Pinta y embolilla papel por las líneas.

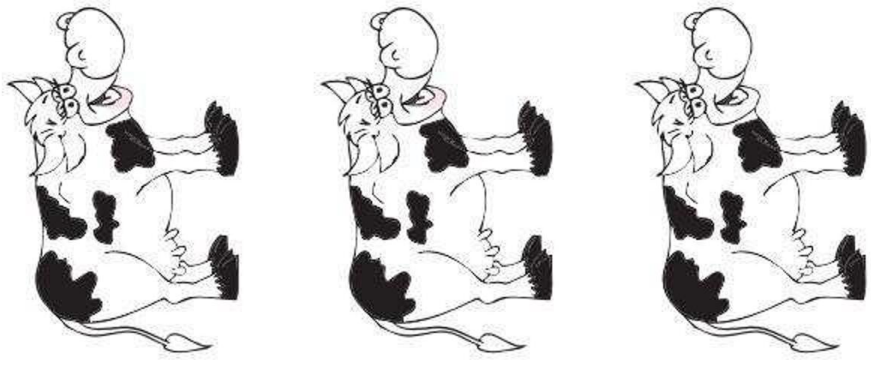
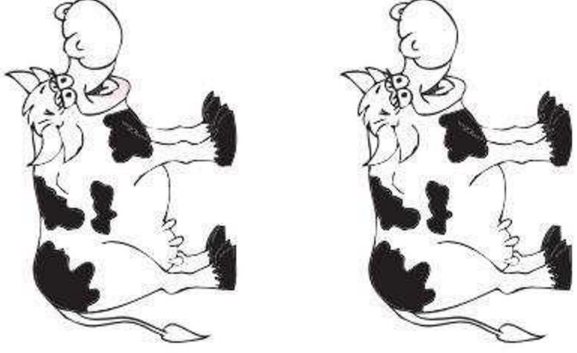
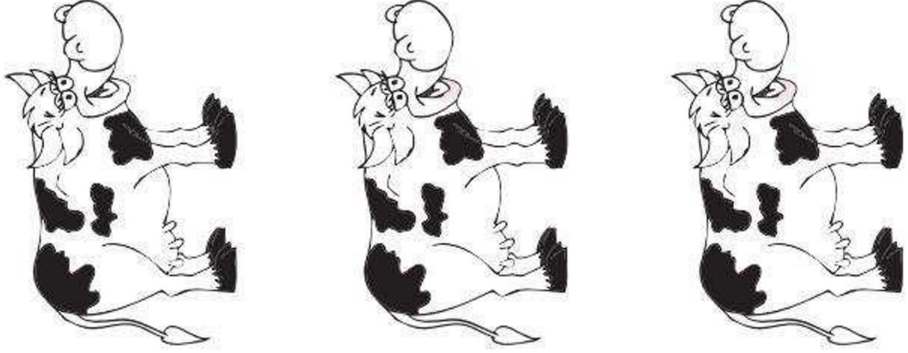
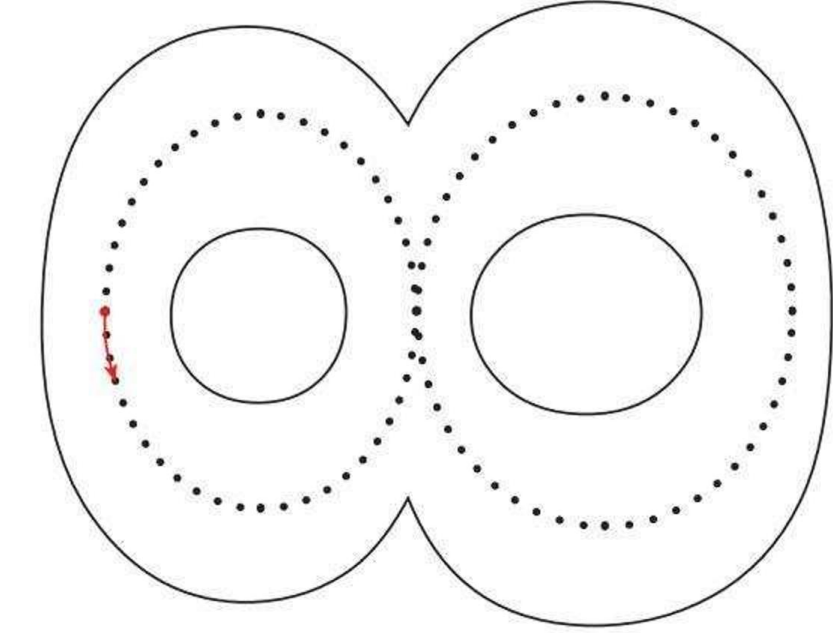



Pinta los globos y repasa por los puntos.

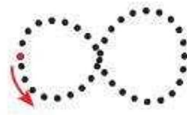
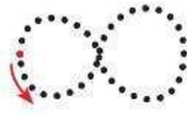
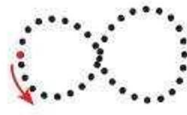
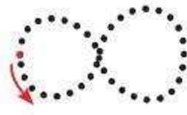
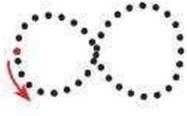
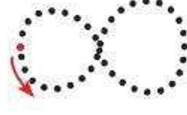
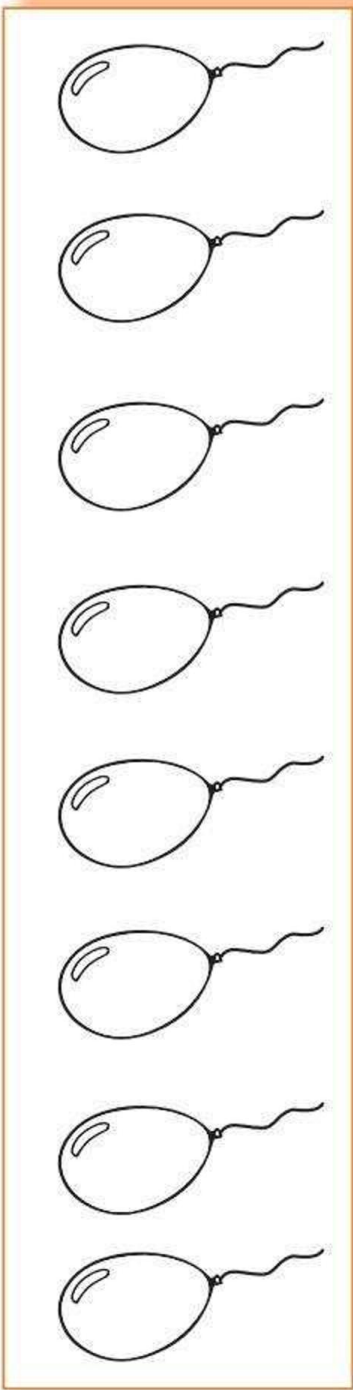

Igual - Diferente



Colorea los peces iguales al modelo.

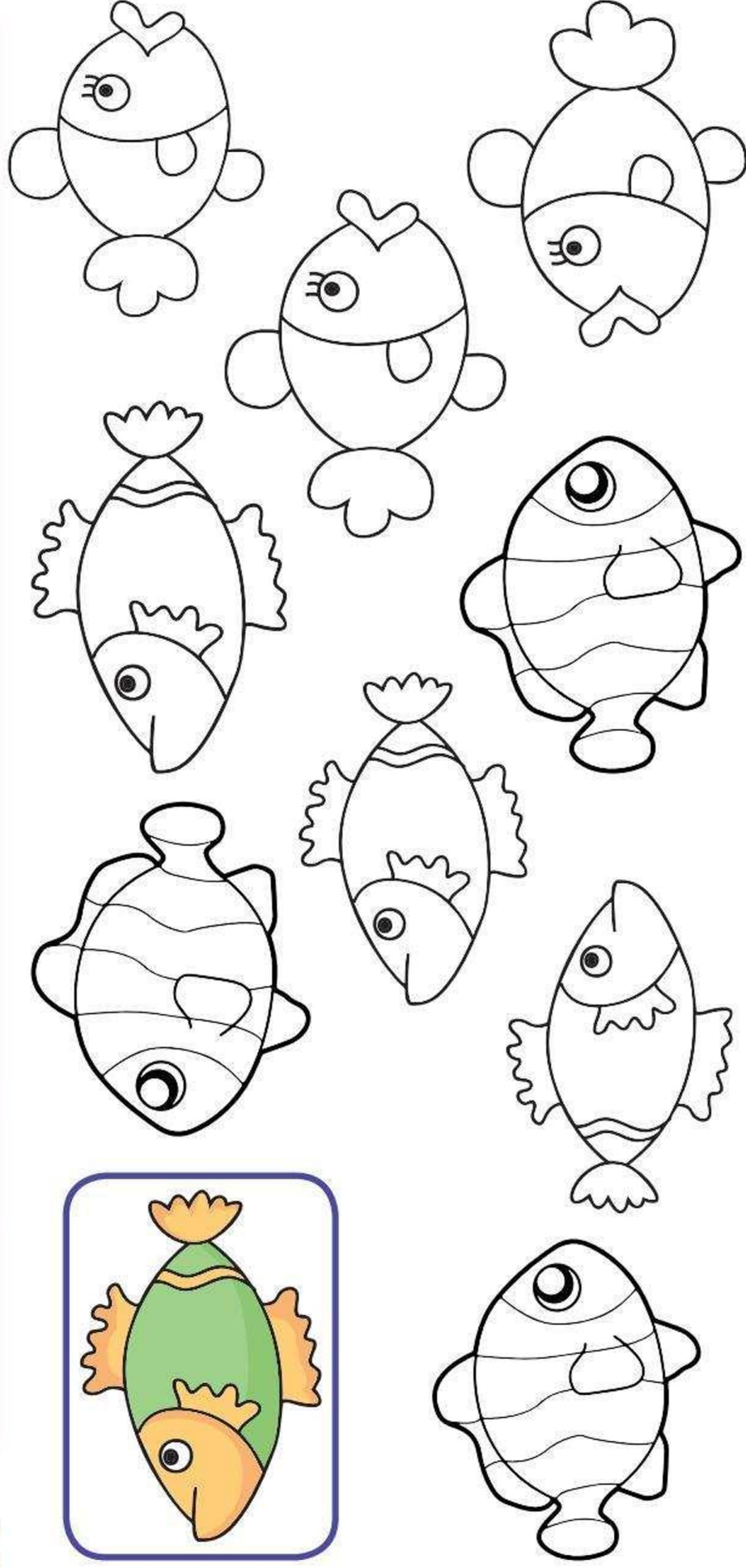
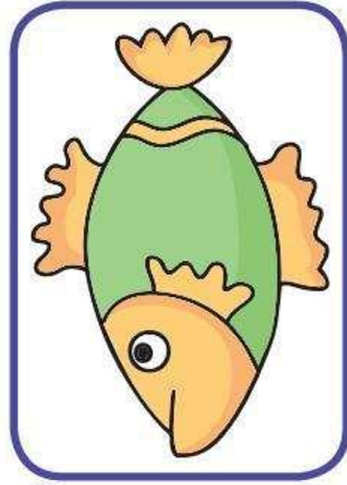

Rectángulo



Pega serpentina al borde del rectángulo. Repasa los rectángulos y pinta de colores.

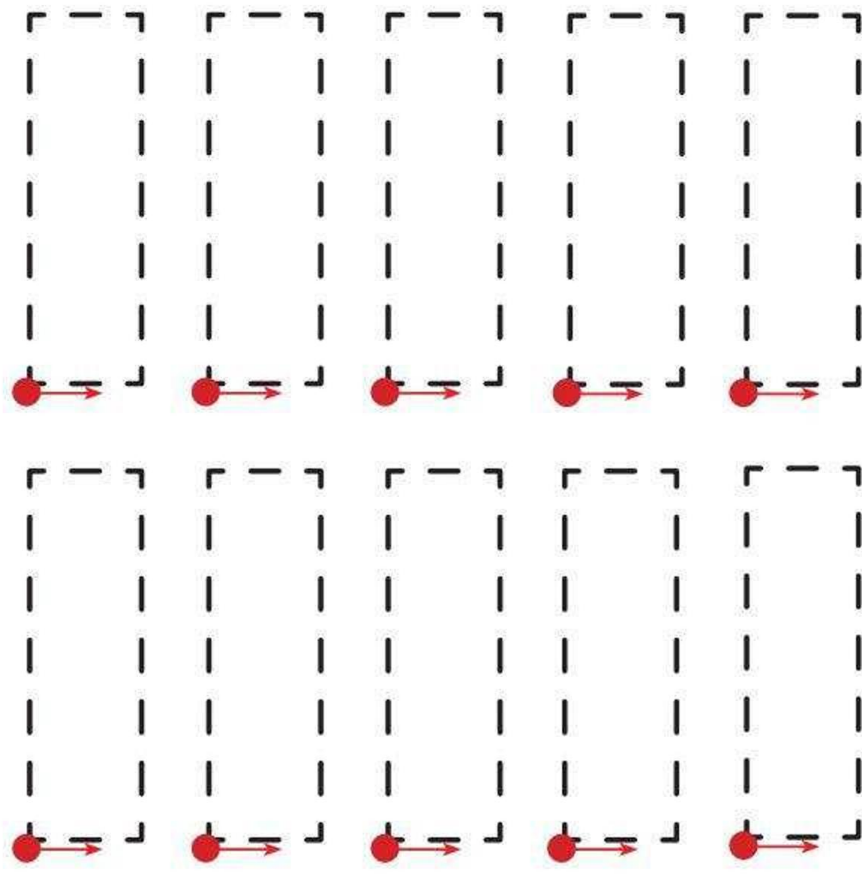
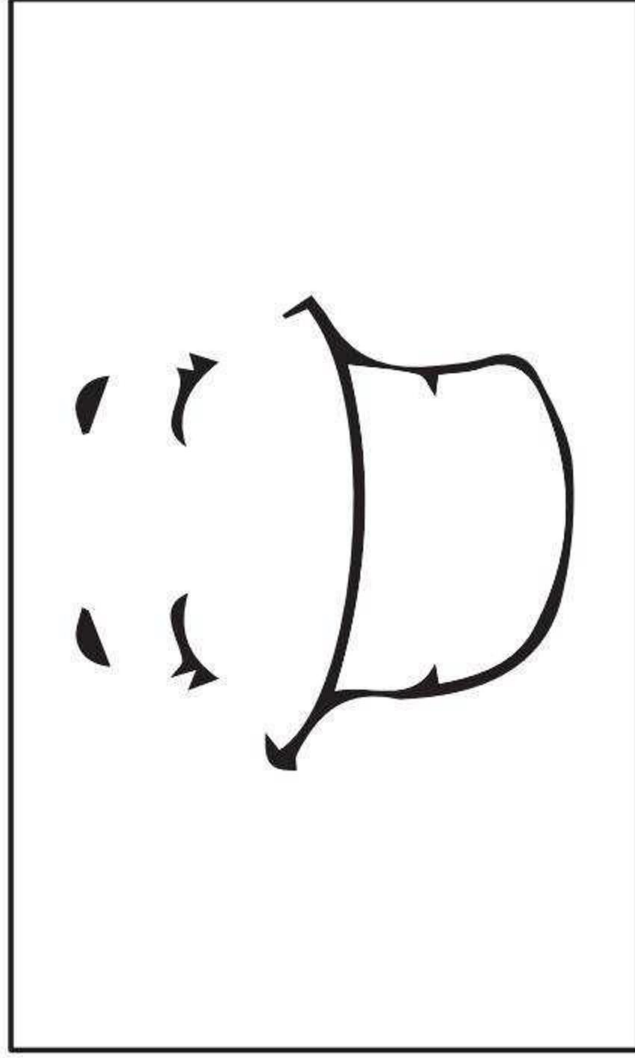

Rectángulo



Dibuja siguiendo la línea de puntos del rectángulo.

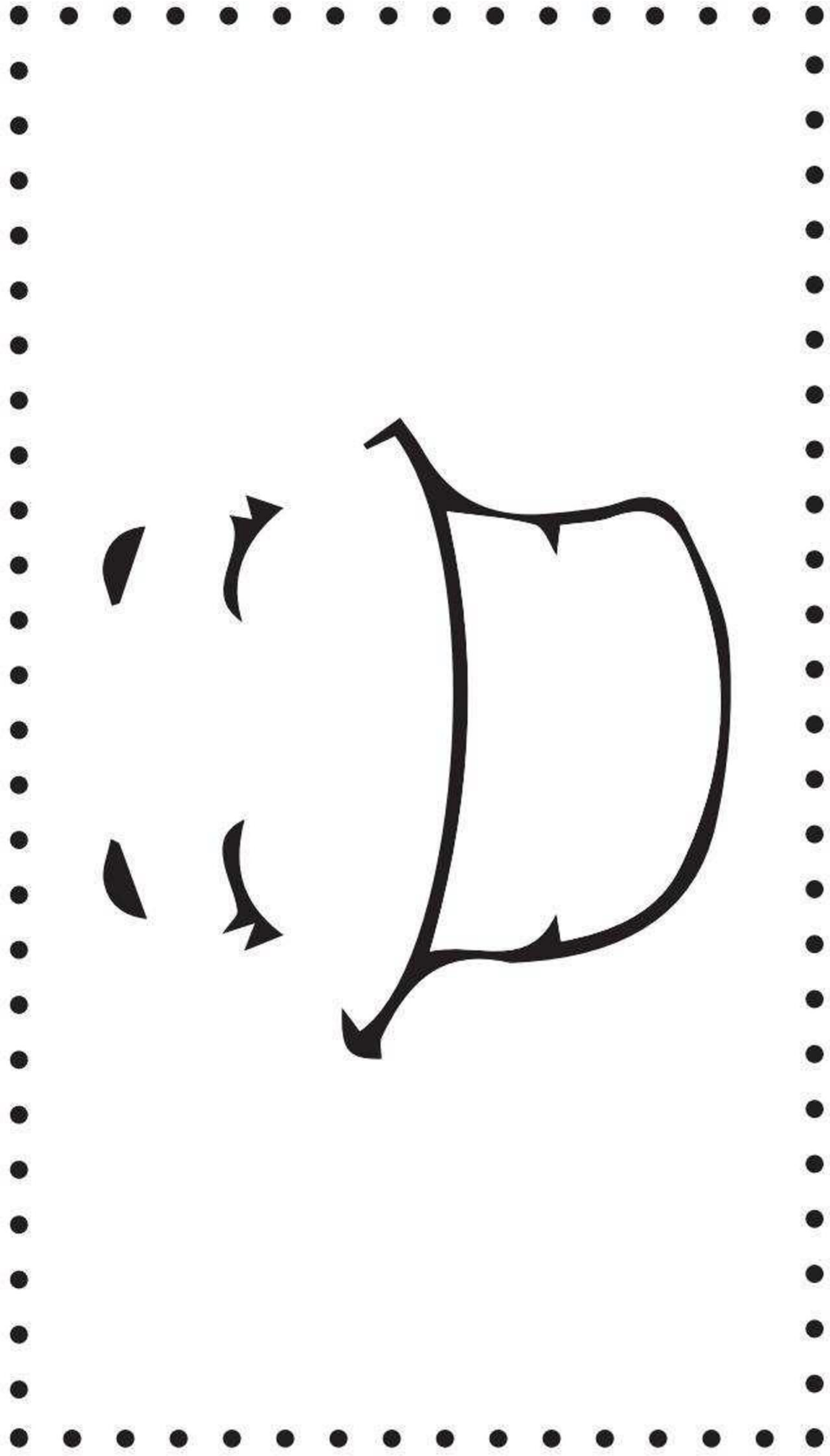

Figuras simples



Repasa los cuadrados, círculos y triángulos. Colorea los dibujos de caras.

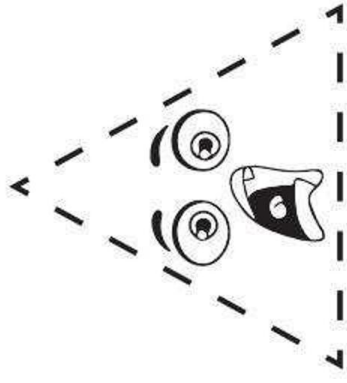
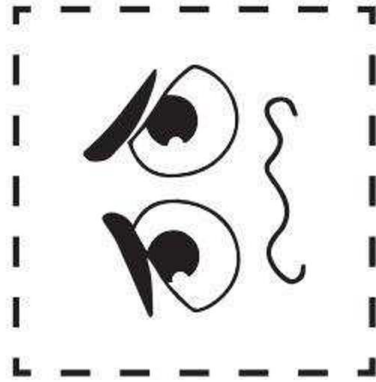
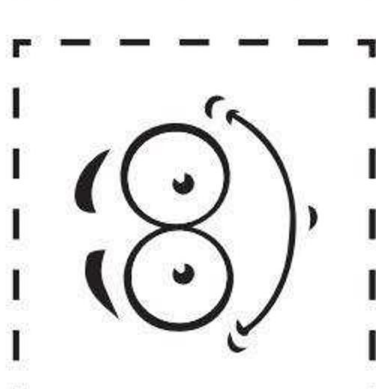
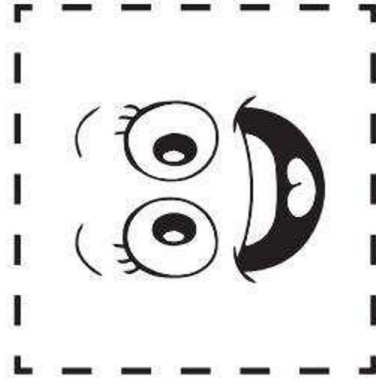
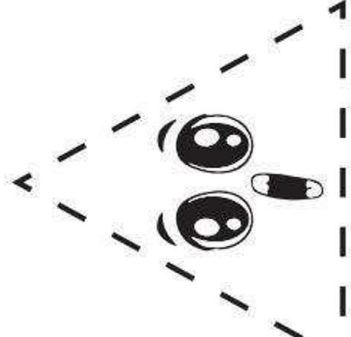
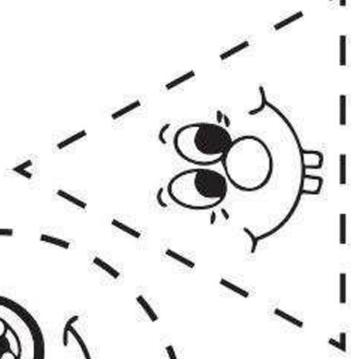
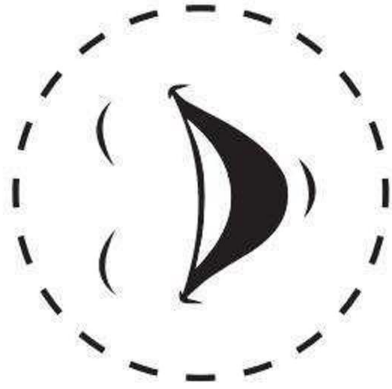

Ovalo



Pega cascaras de huevo
dentro del óvalo.

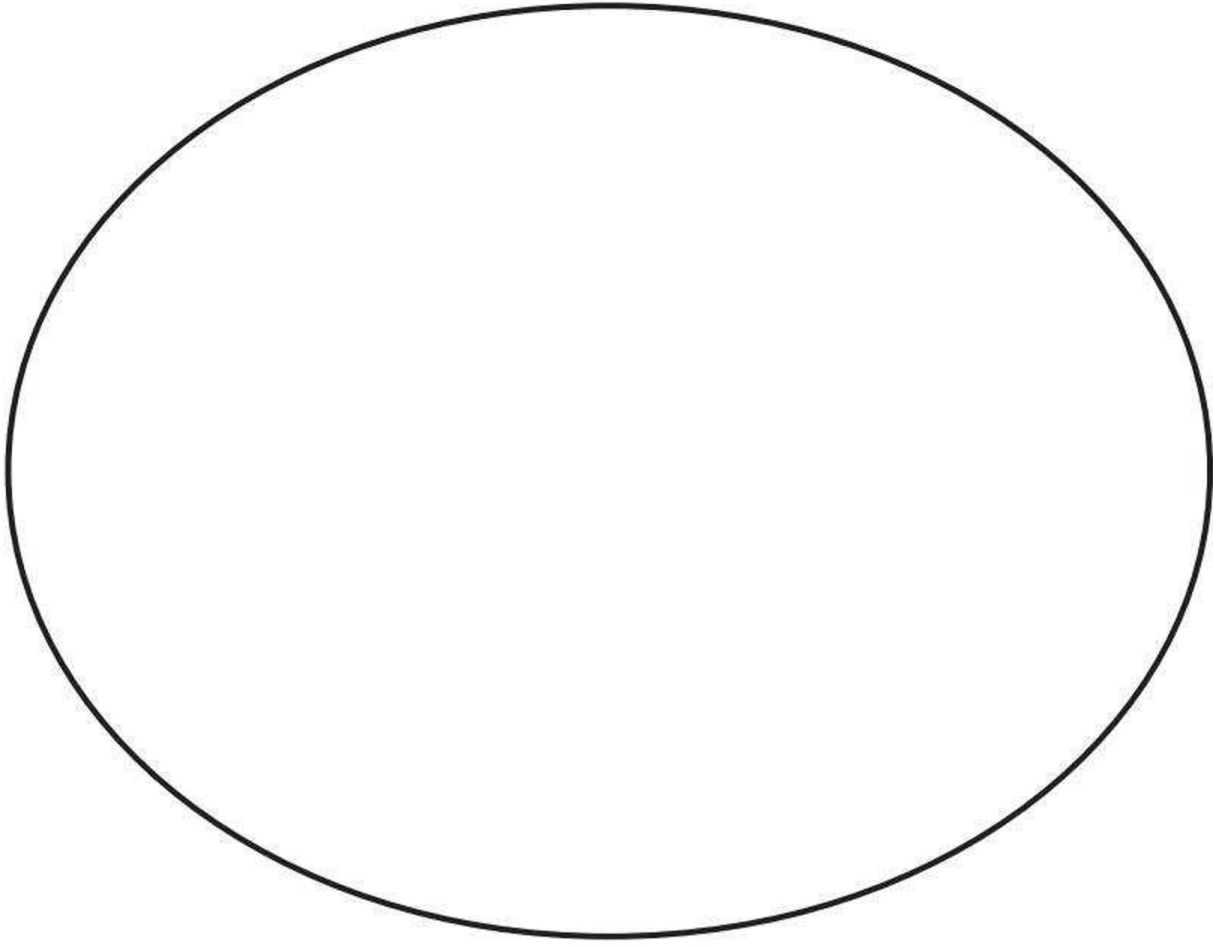

Absurdos



Encierra en un círculo los absurdos que encuentres en la imagen.



Número 9



Deja tus huellitas con tempera en el número 9 y colorea las imágenes.

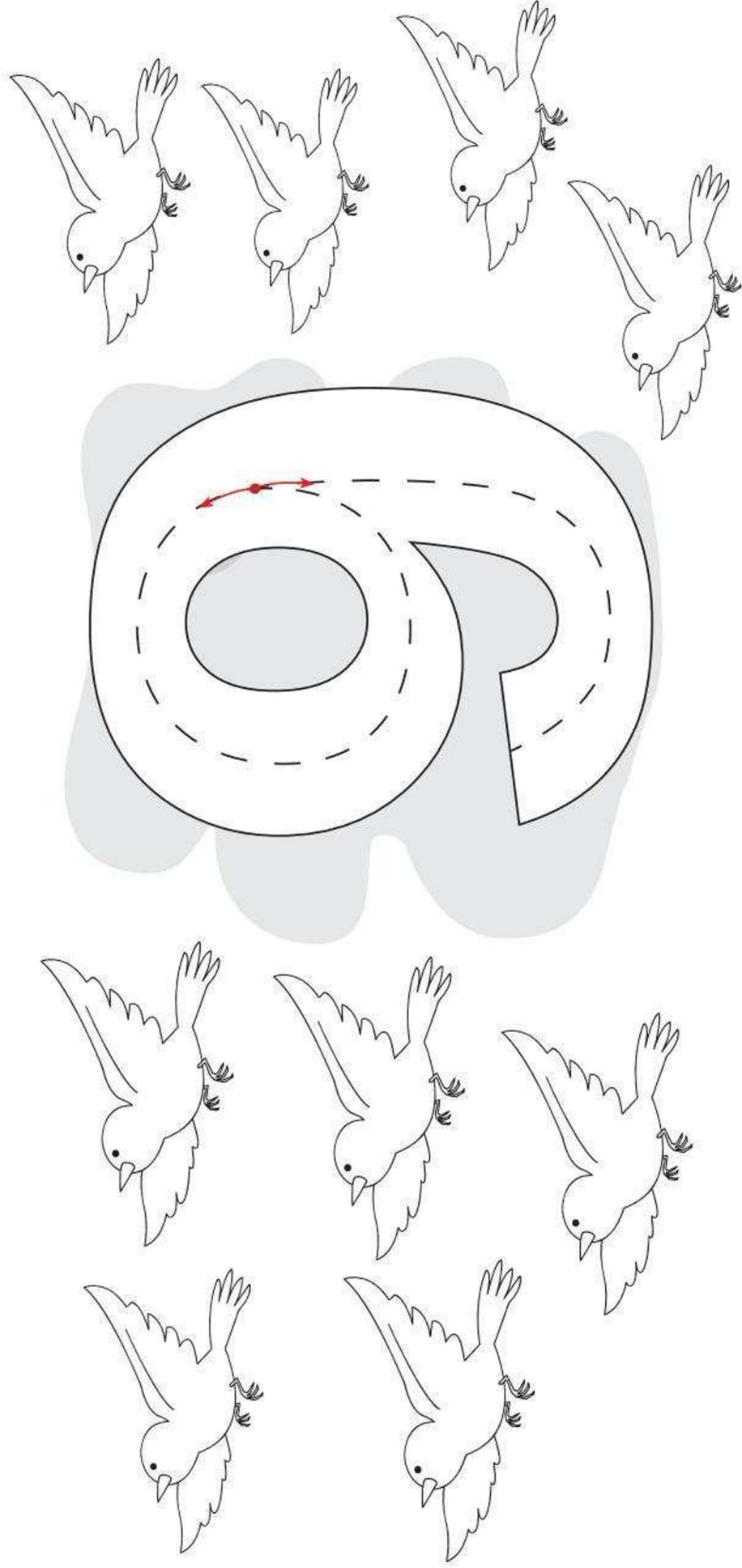

Número 9

Repasa y colorea. Colorear nueve jarras.

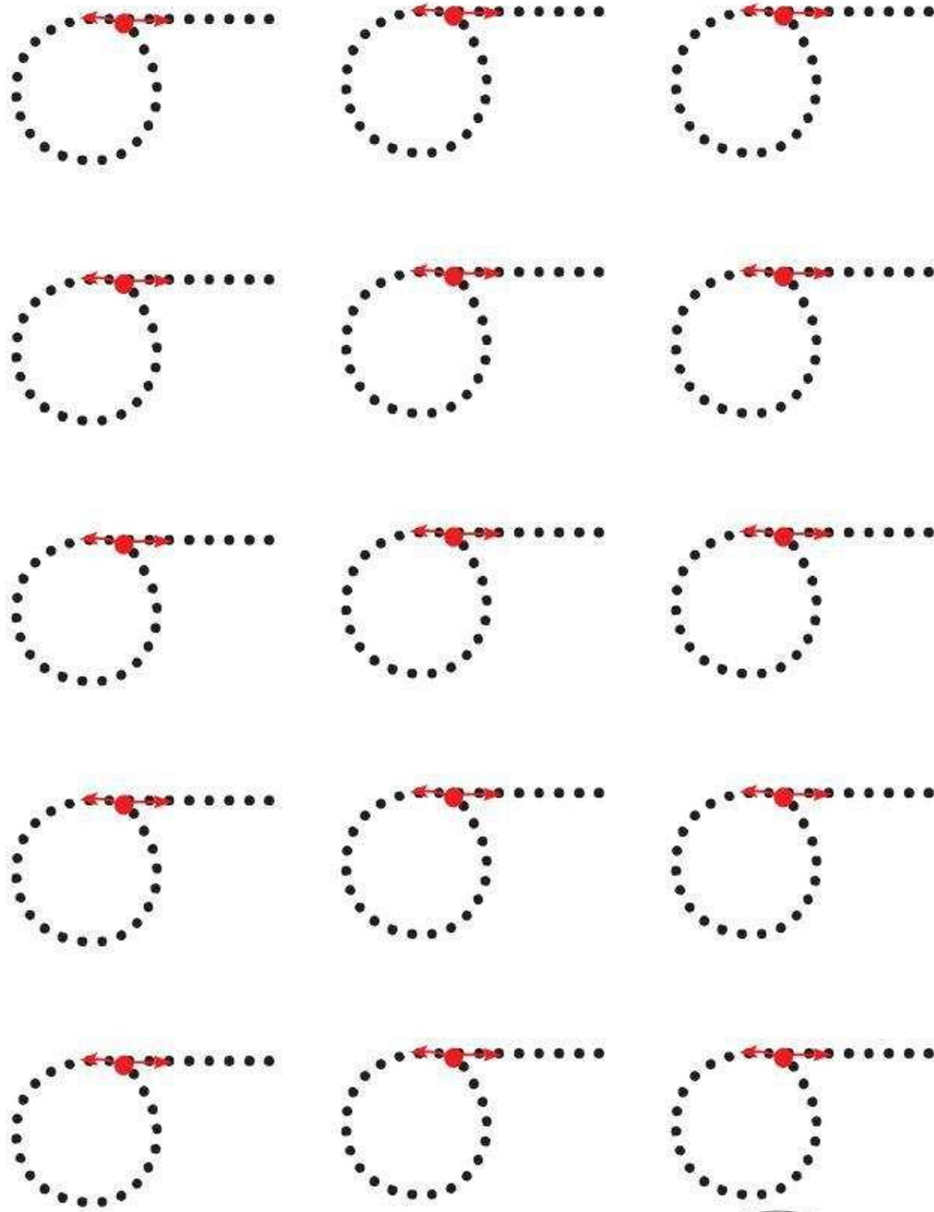
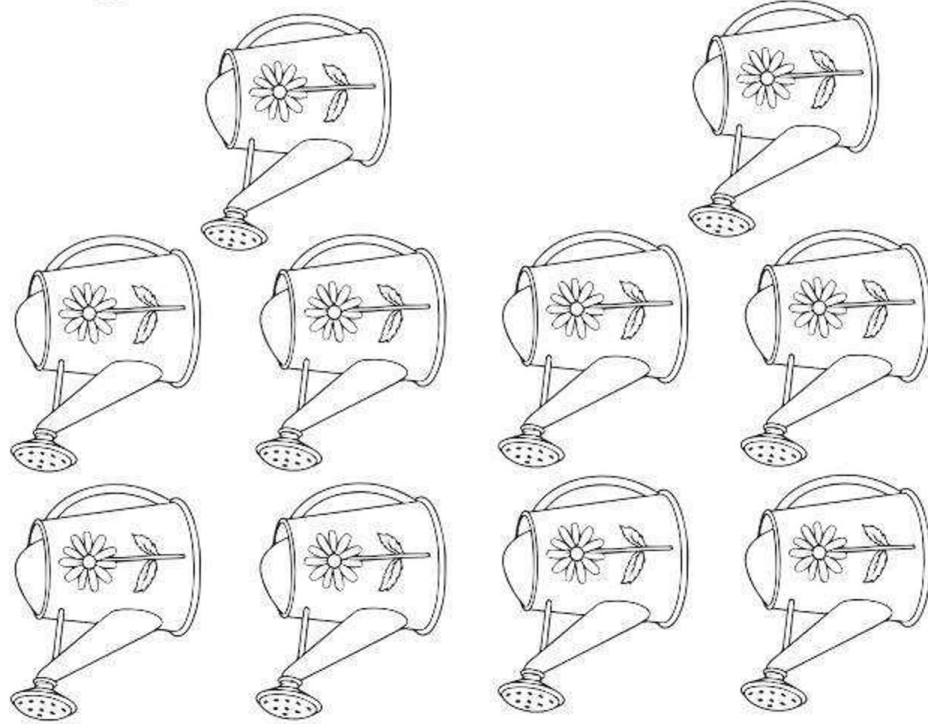

Número 10

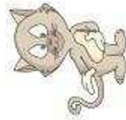

Pinta el número 10 cada uno de diferentes colores.

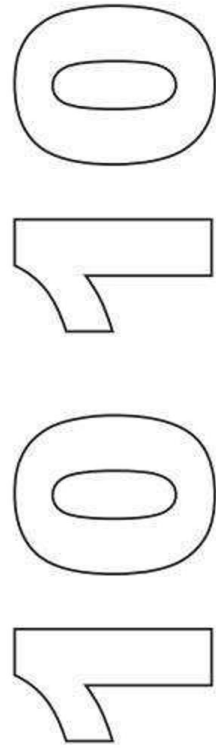
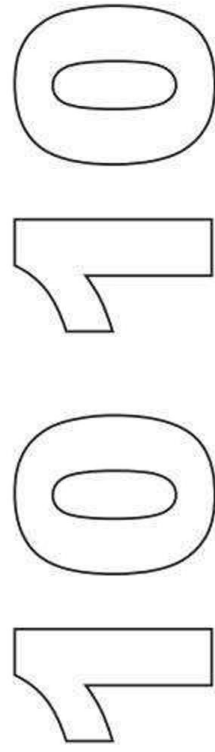
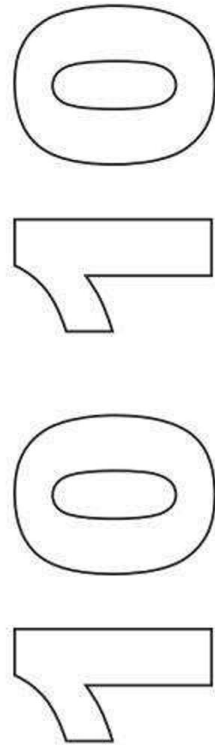
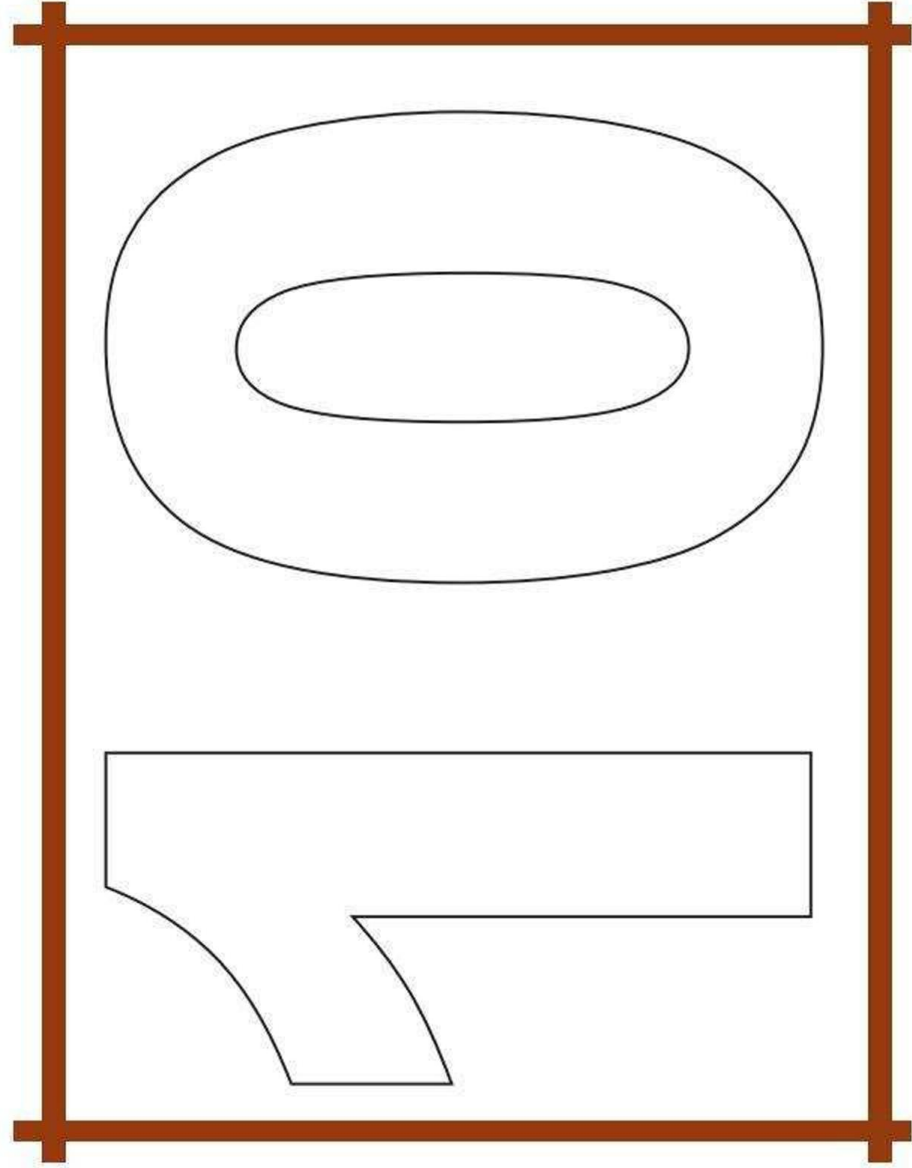

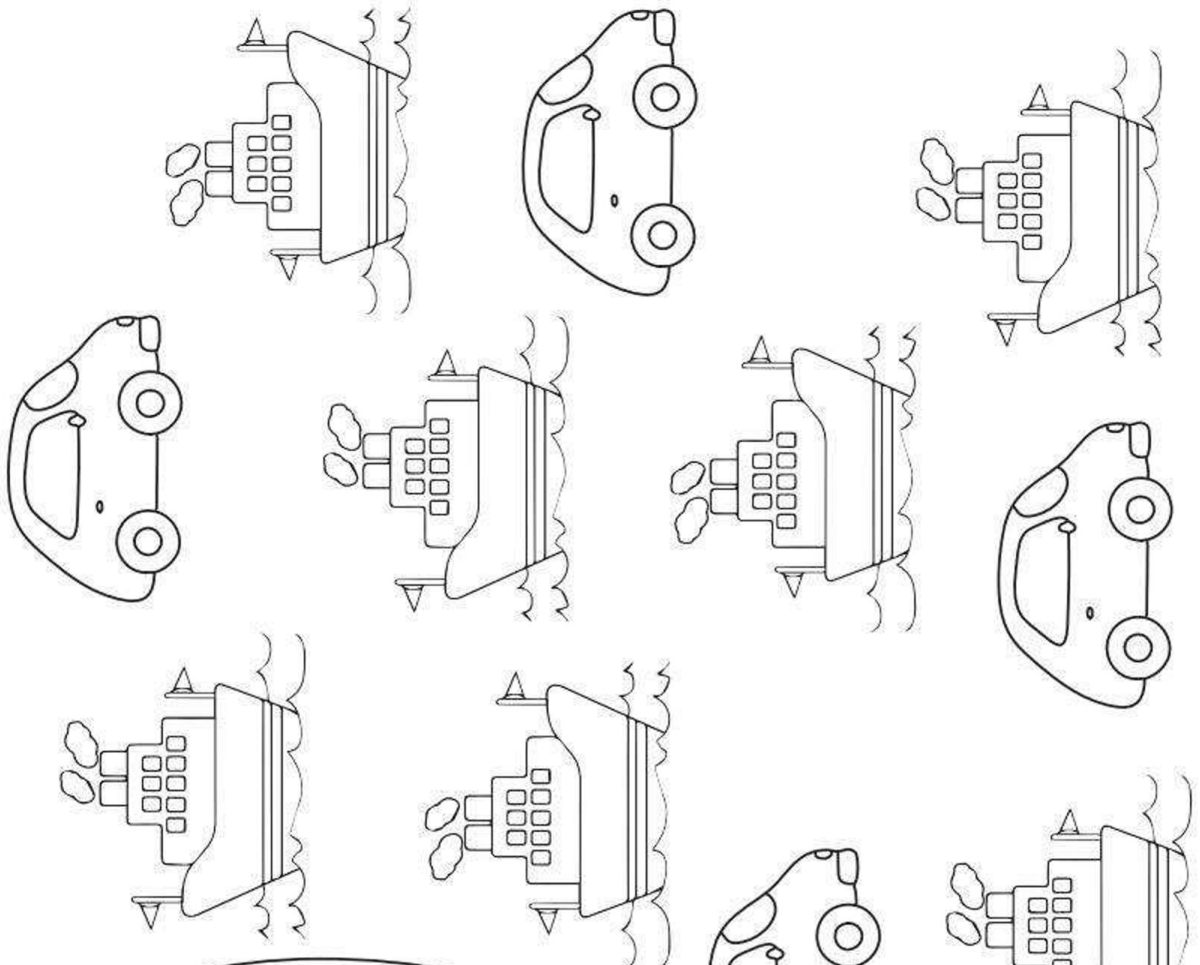

O

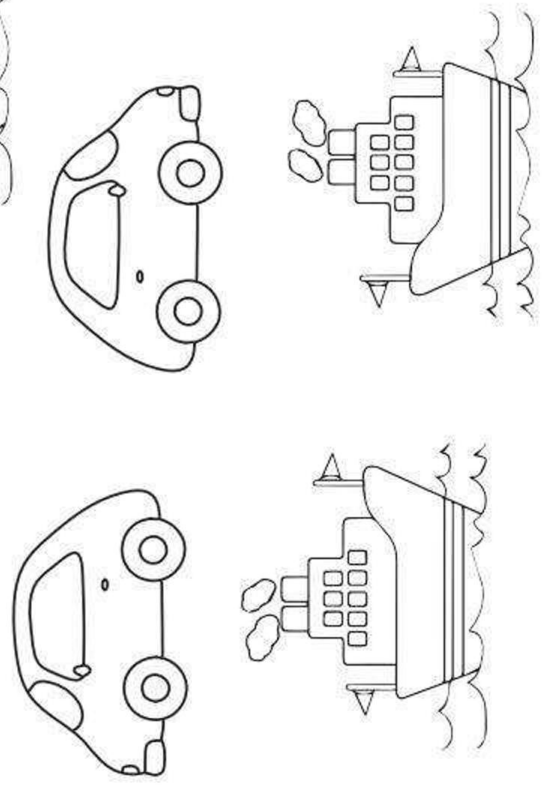

R

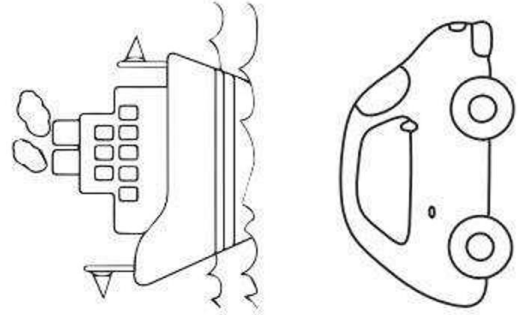

Práctica de los números del 1 al 10



Completa la serie de números y pinta el gusano de colores.

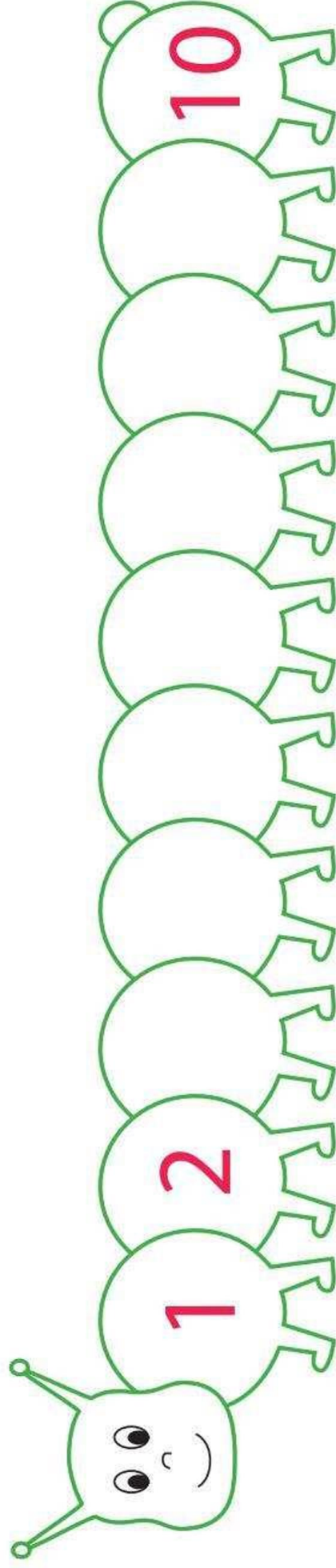

Grande - Mediano - Pequeño



Rasga papel de colores y pega en el payaso mediano.

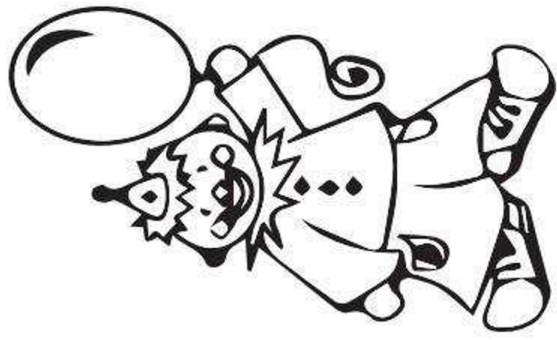
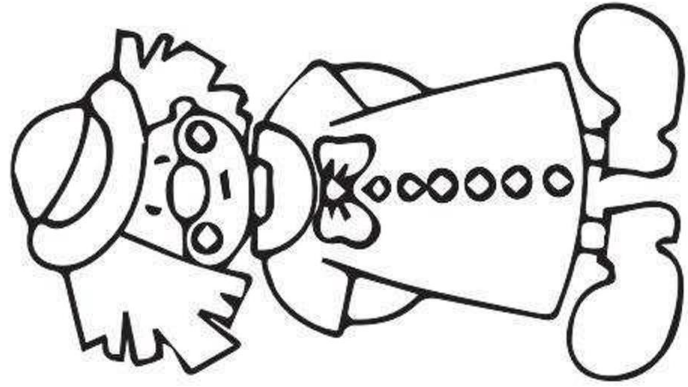
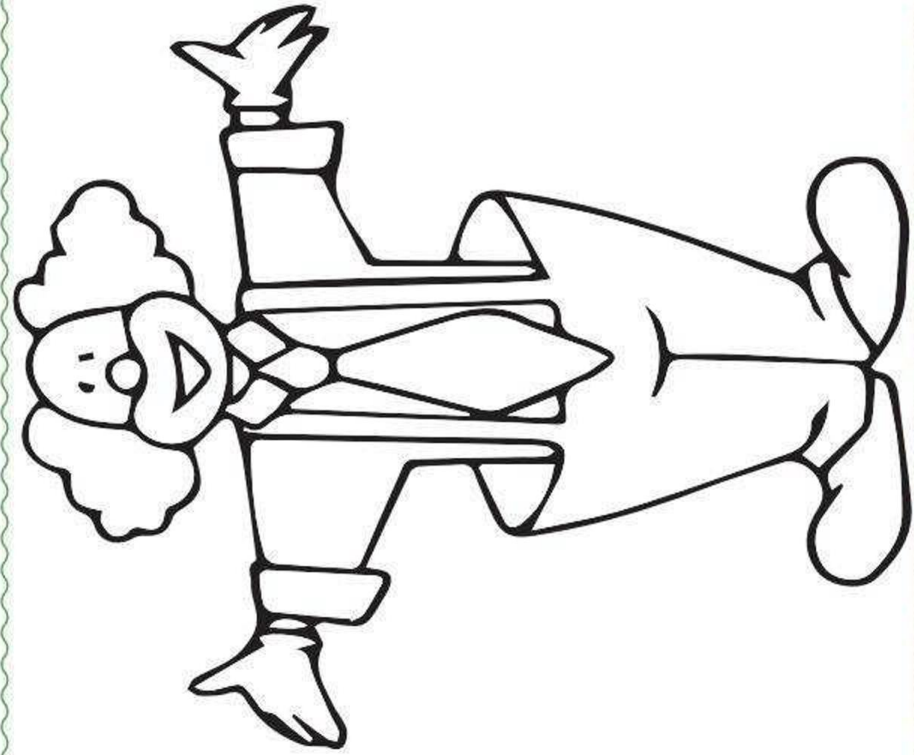



Colorea los lápices grandes y enciérralos con una línea.

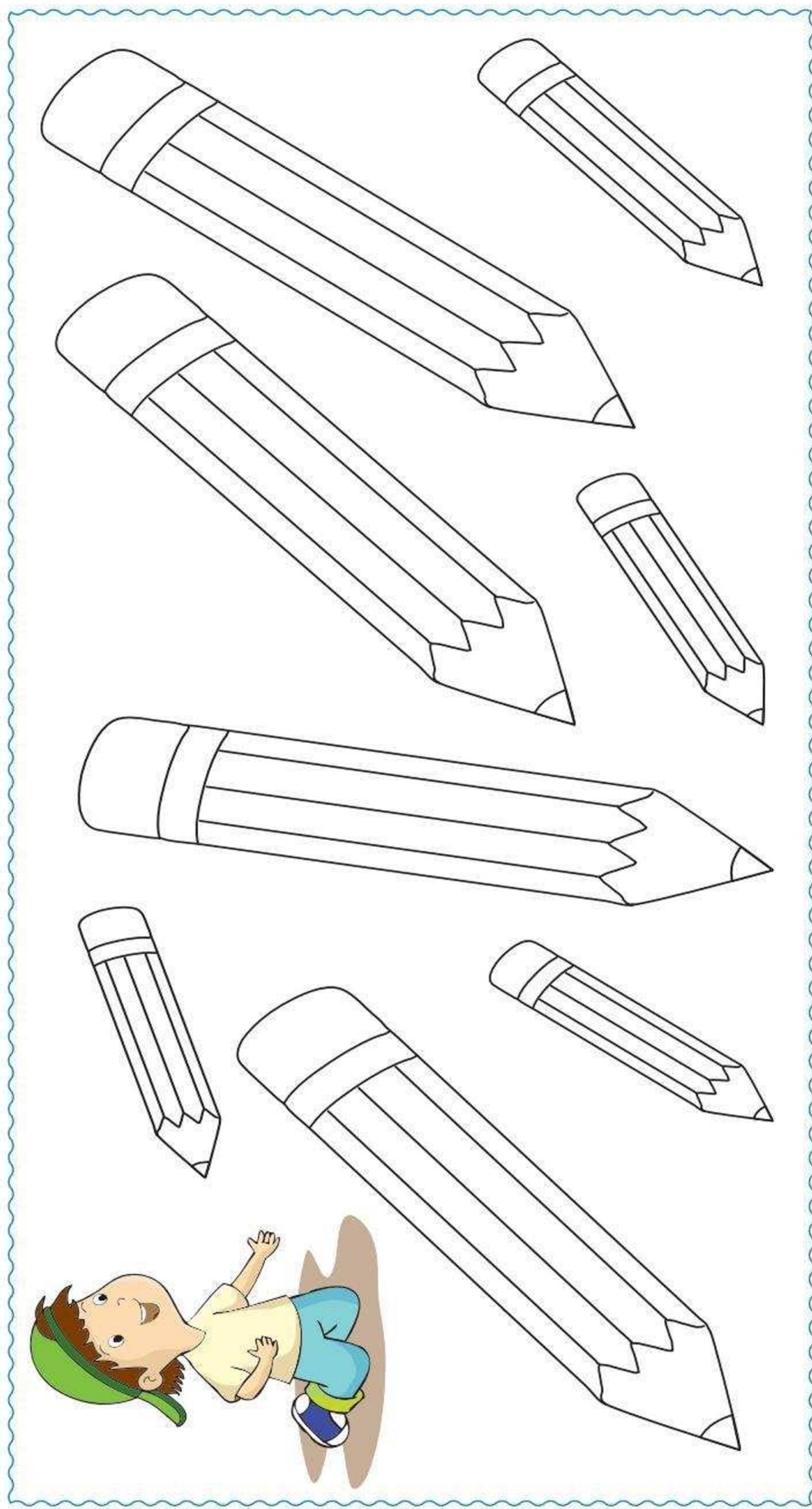

Entero = Mitad



Encierra en un círculo la palta que esta partida. Marca con una (X) la naranja entera.

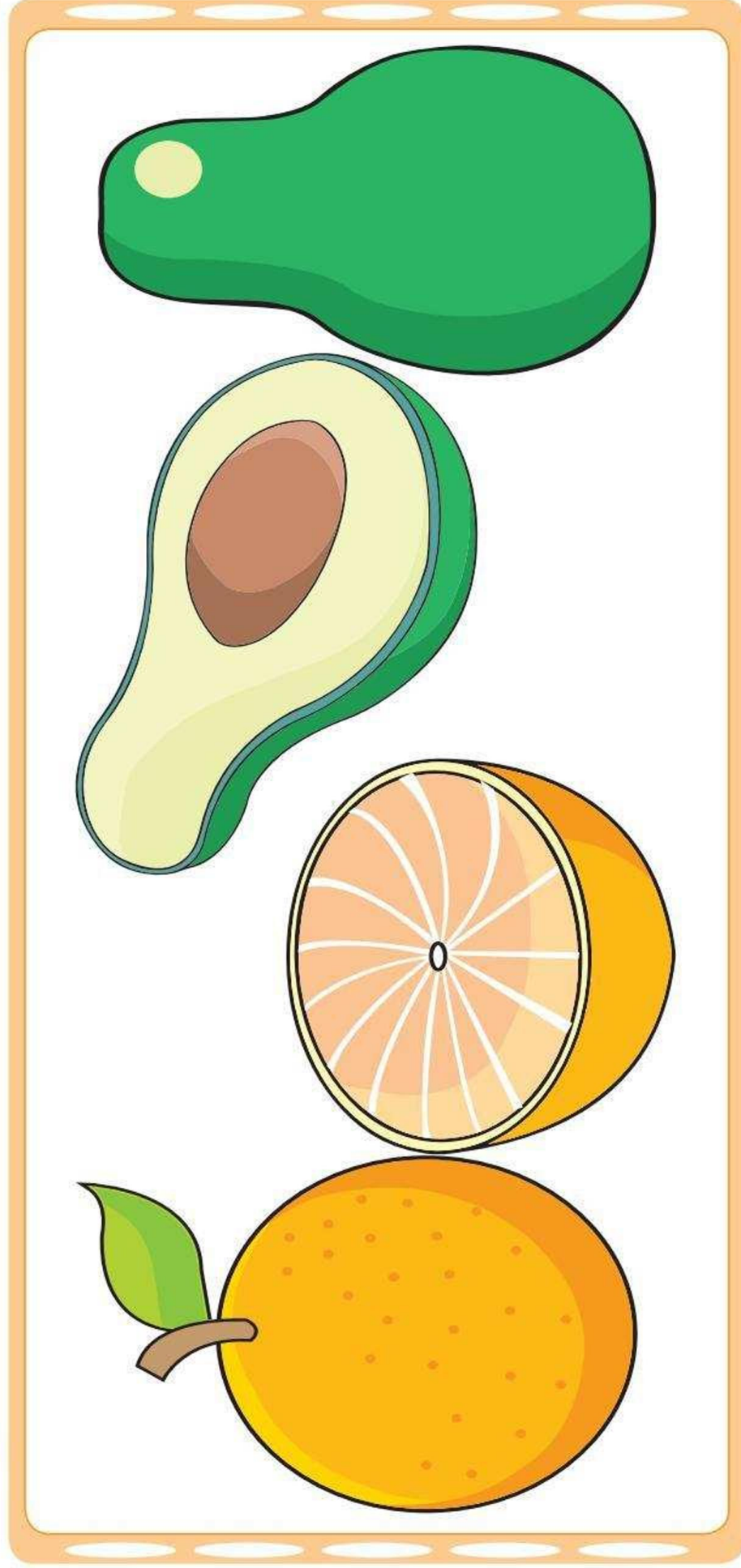



Entero - Partido

Deja tus huellitas de témperas en la sandía entera, y colorea la sandía que esta a la mitad.

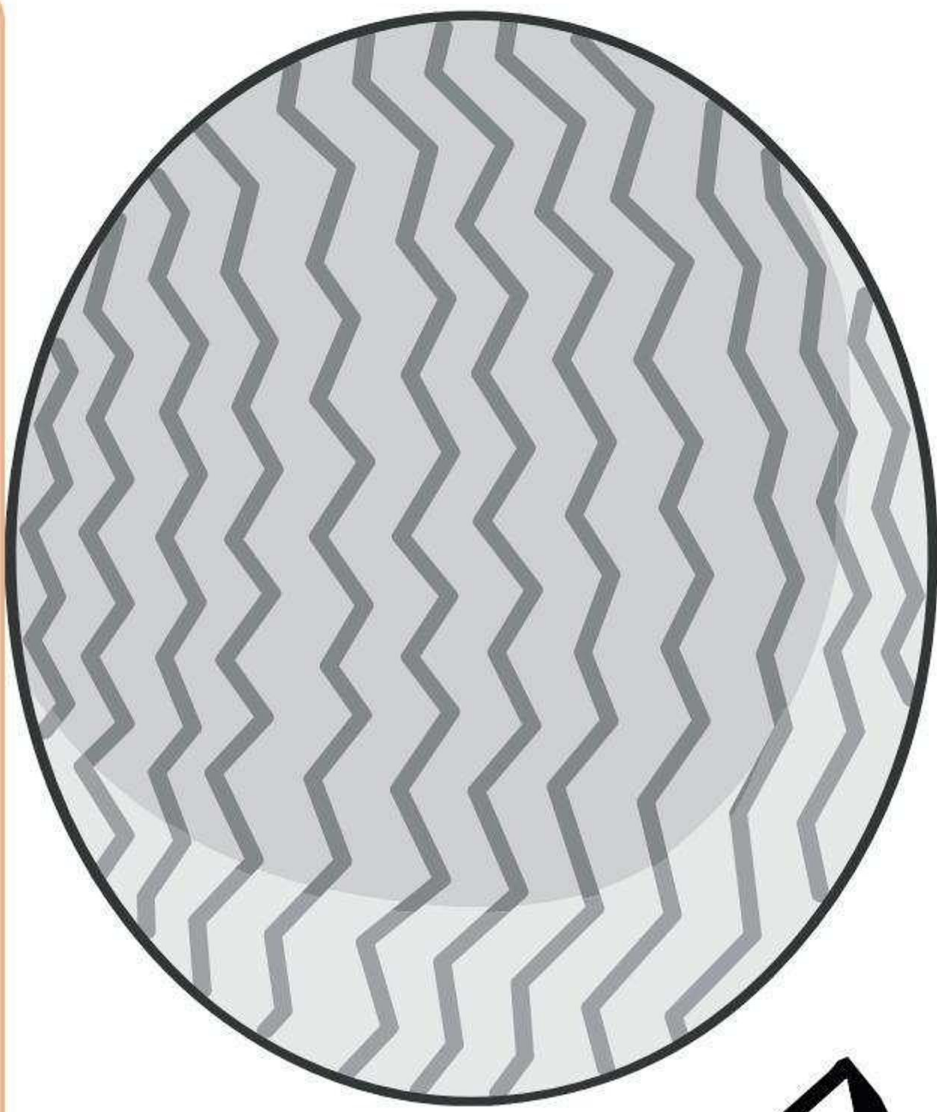
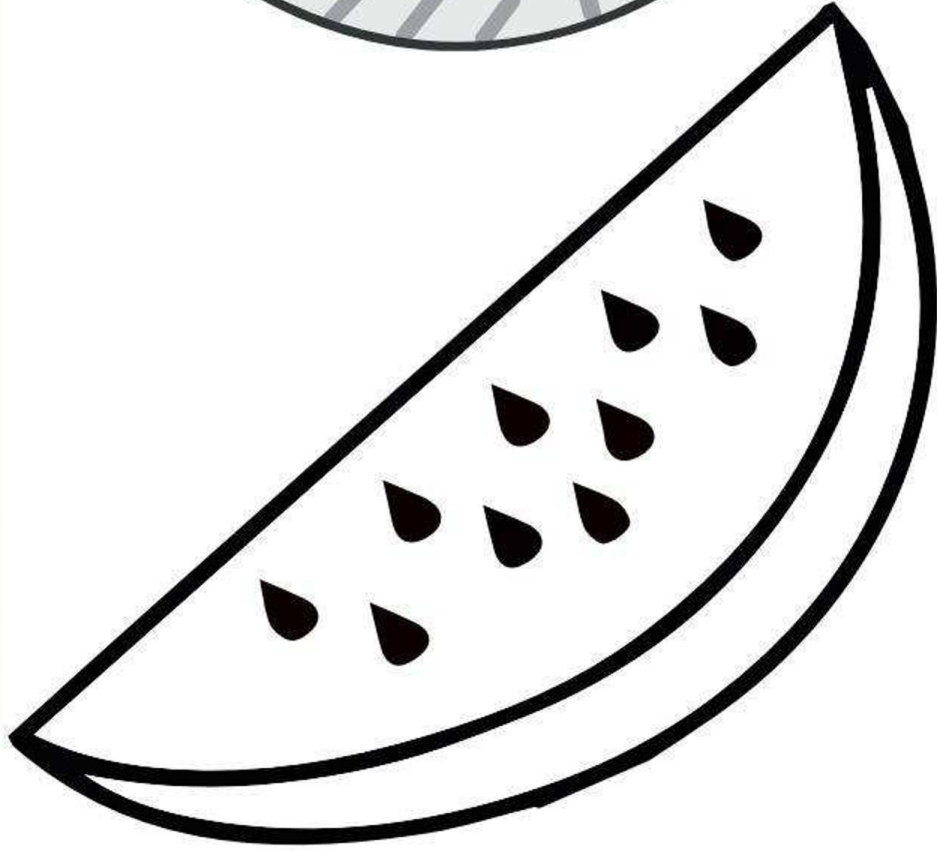



Pega aqui:



Objetos Ocultos

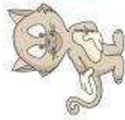

Colorea el serrucho.

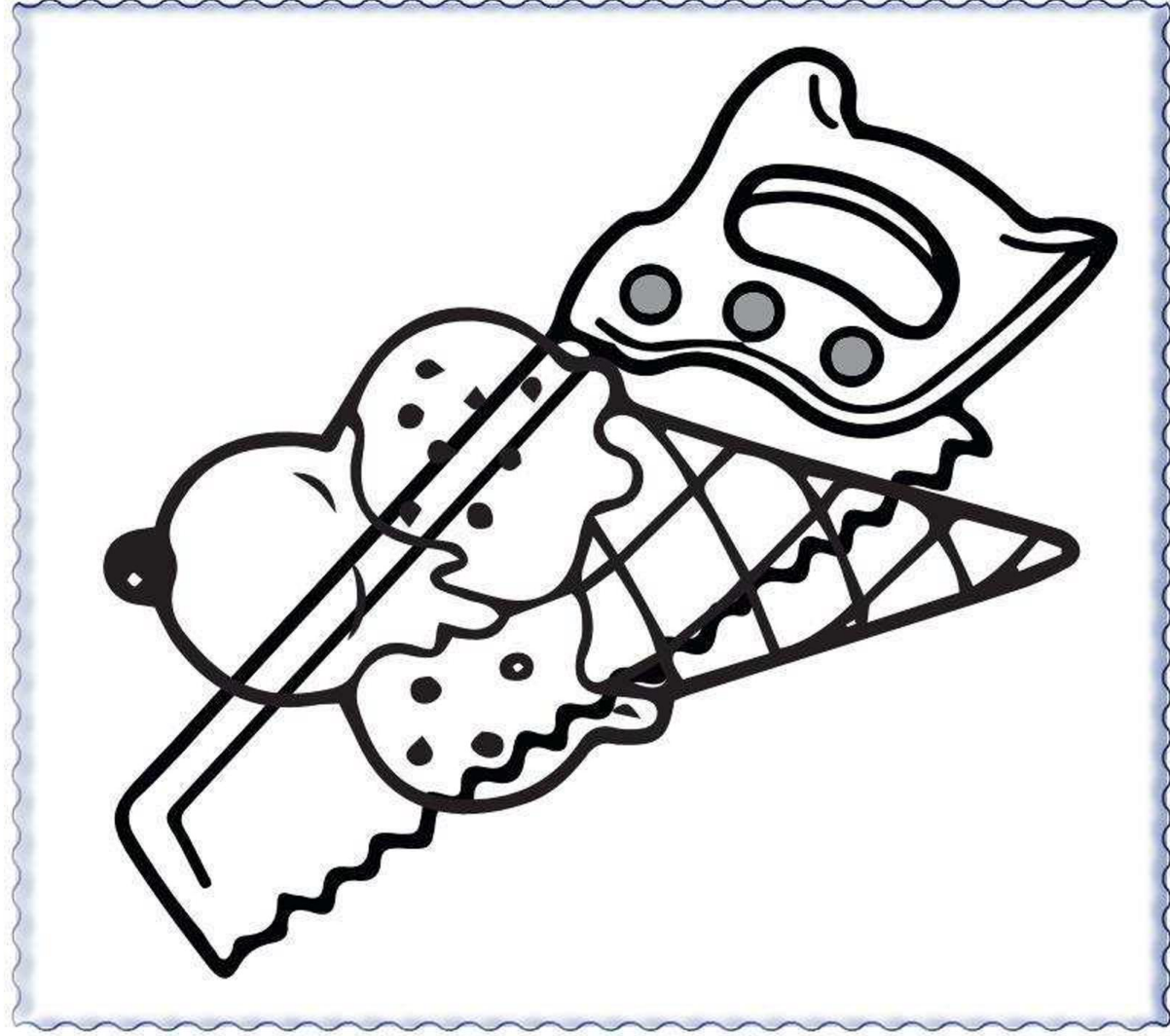

Color blanco



Pega algodón en el conejo.

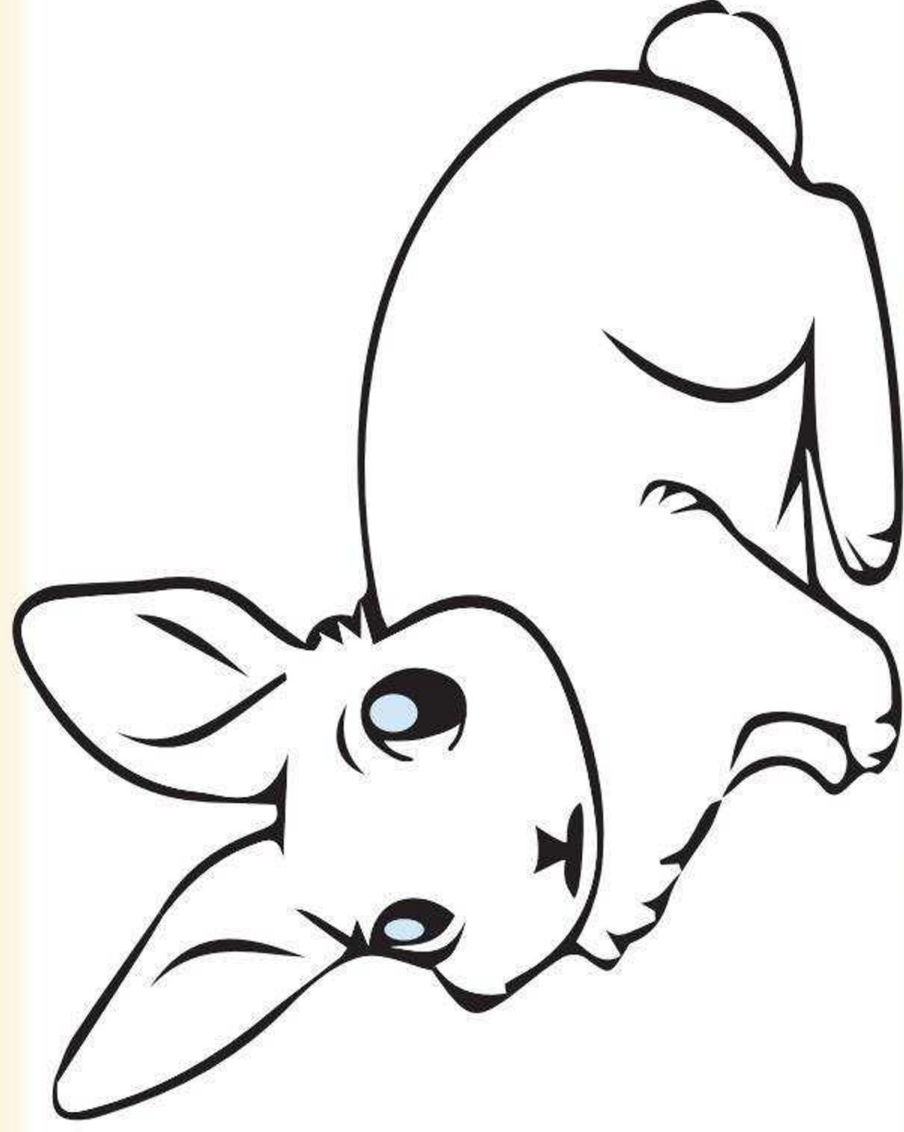

Direccionalidad



Colorea de amarillo los caracoles que van hacia la derecha y de verde los que van hacia la izquierda.

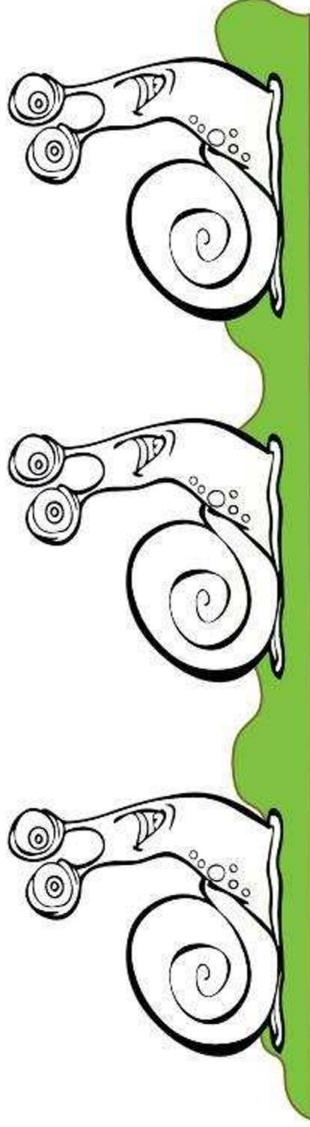
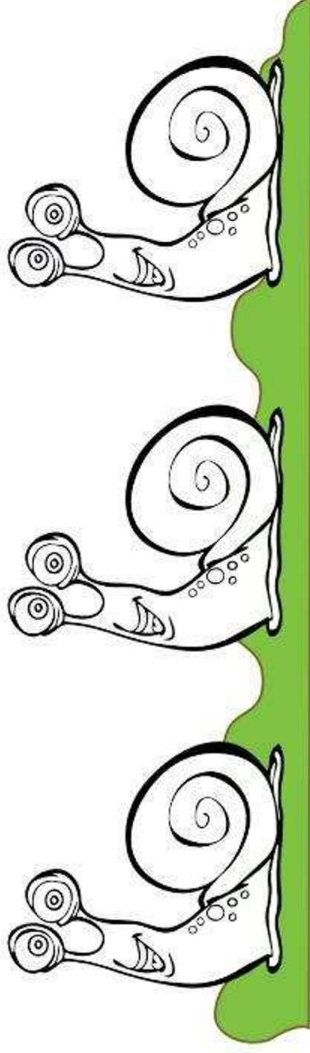

Más = Menos

Colorea donde hay más globos.

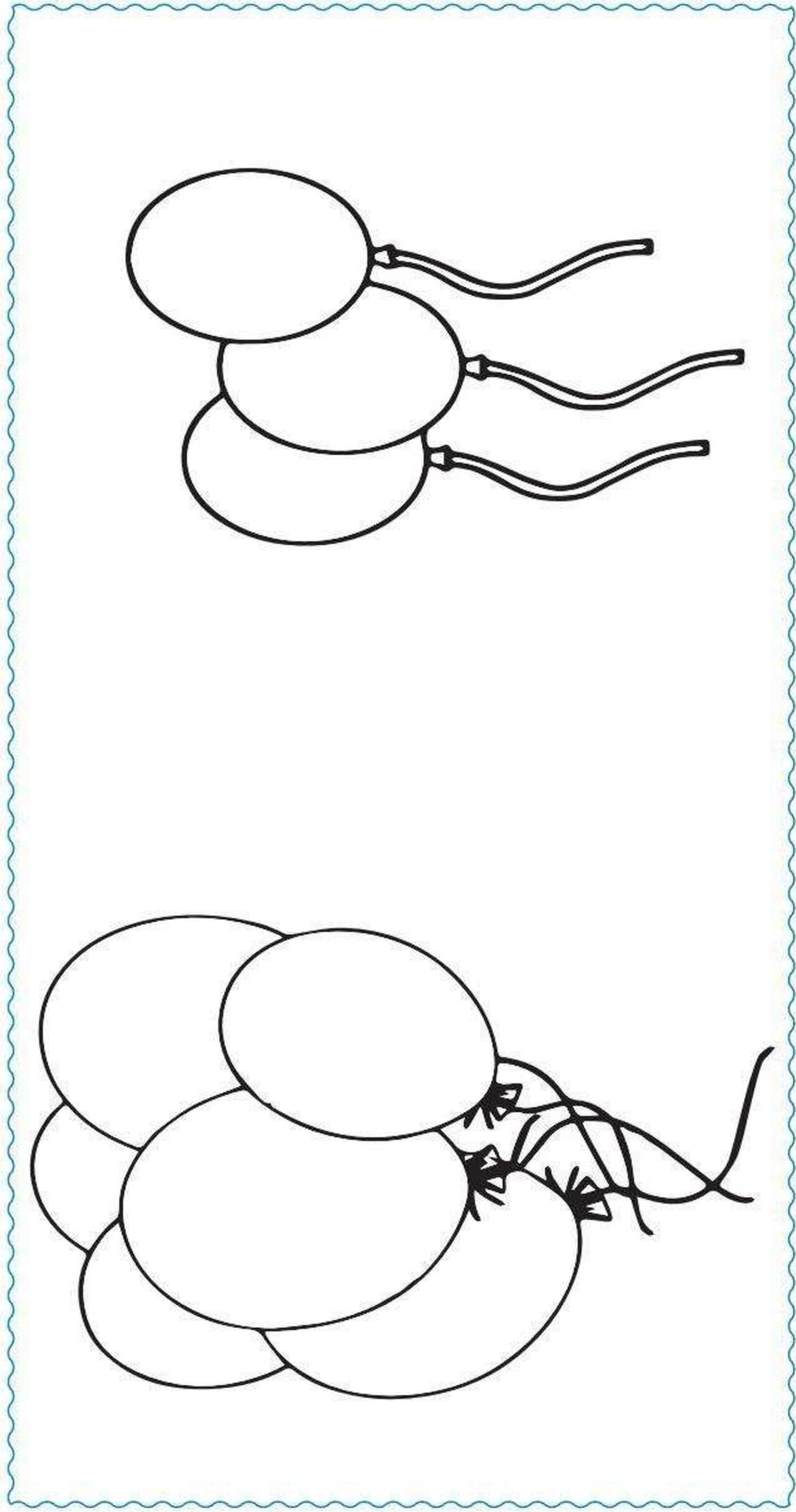



Encierra donde hay más búhos y marca con una (+) donde hay menos búhos.

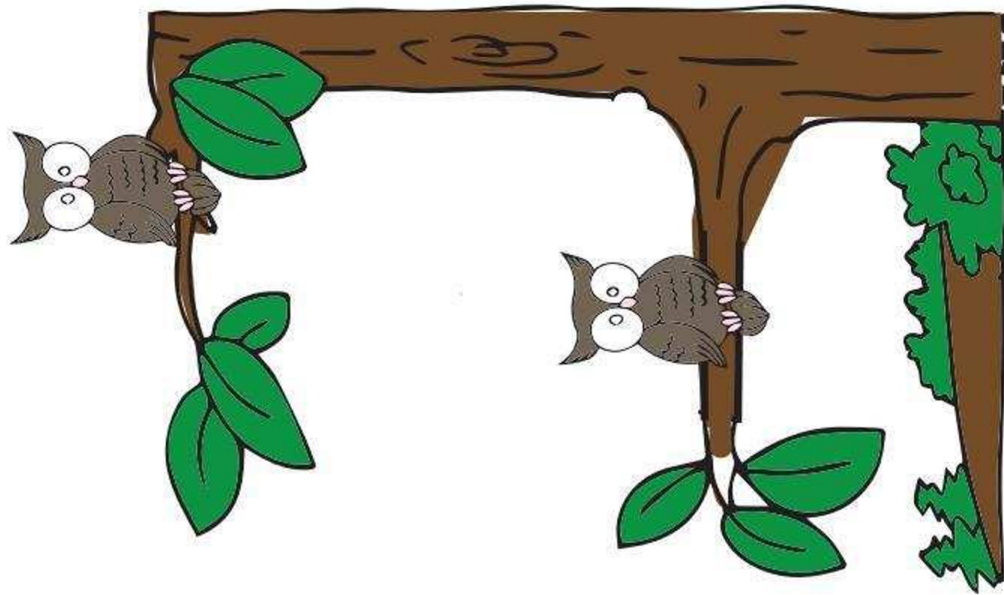
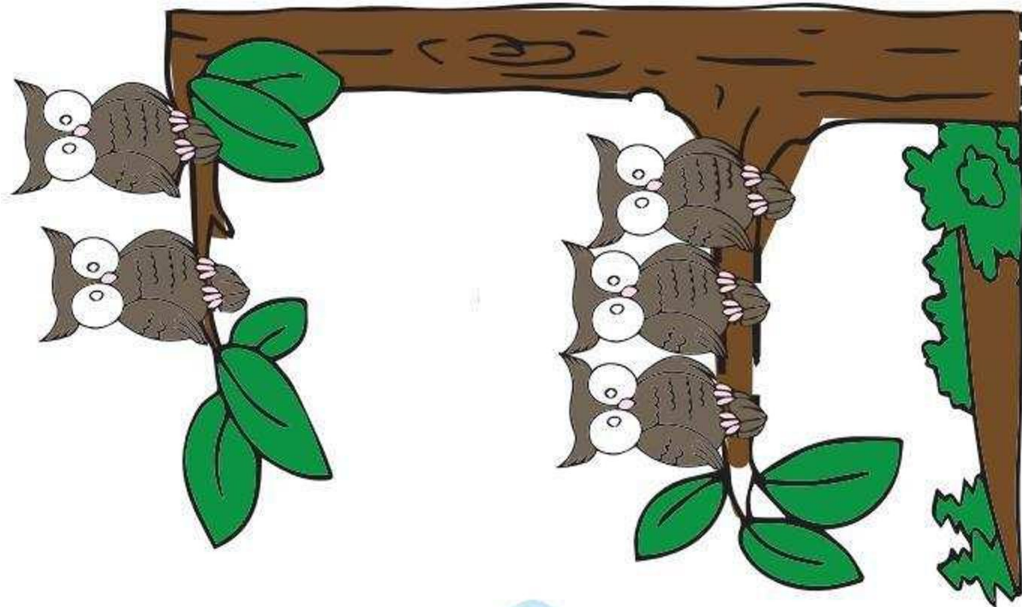

Reproducción de figuras

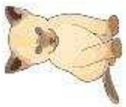

Observa y dibuja según el modelo.

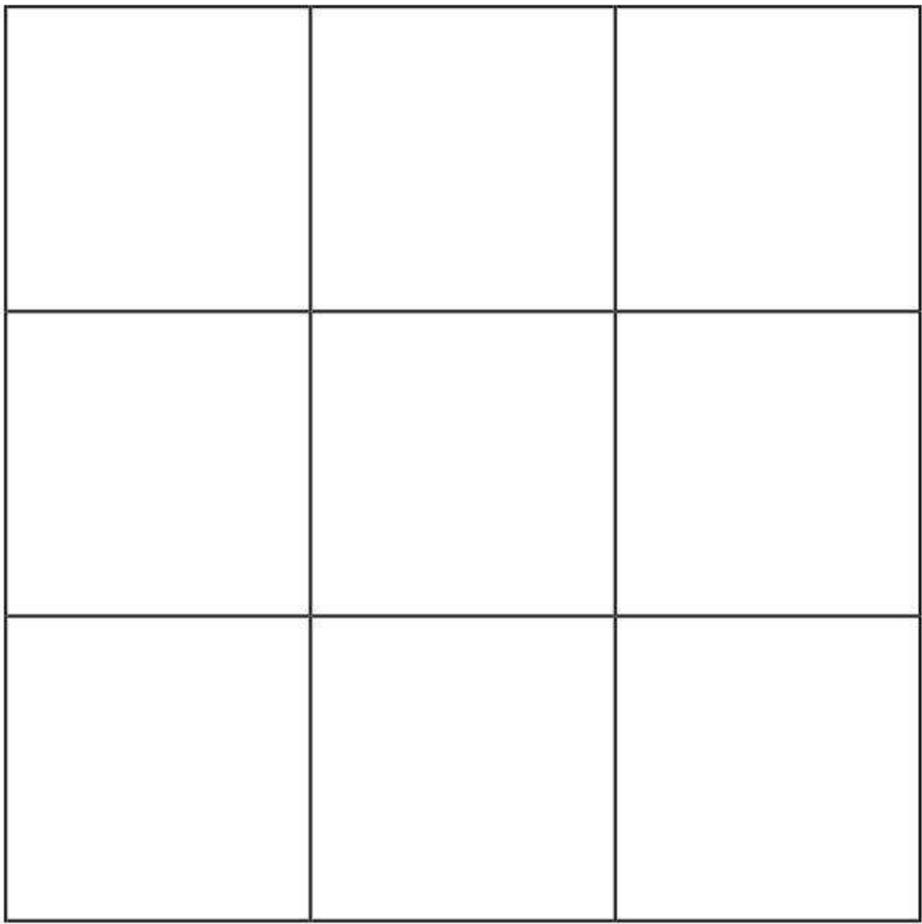
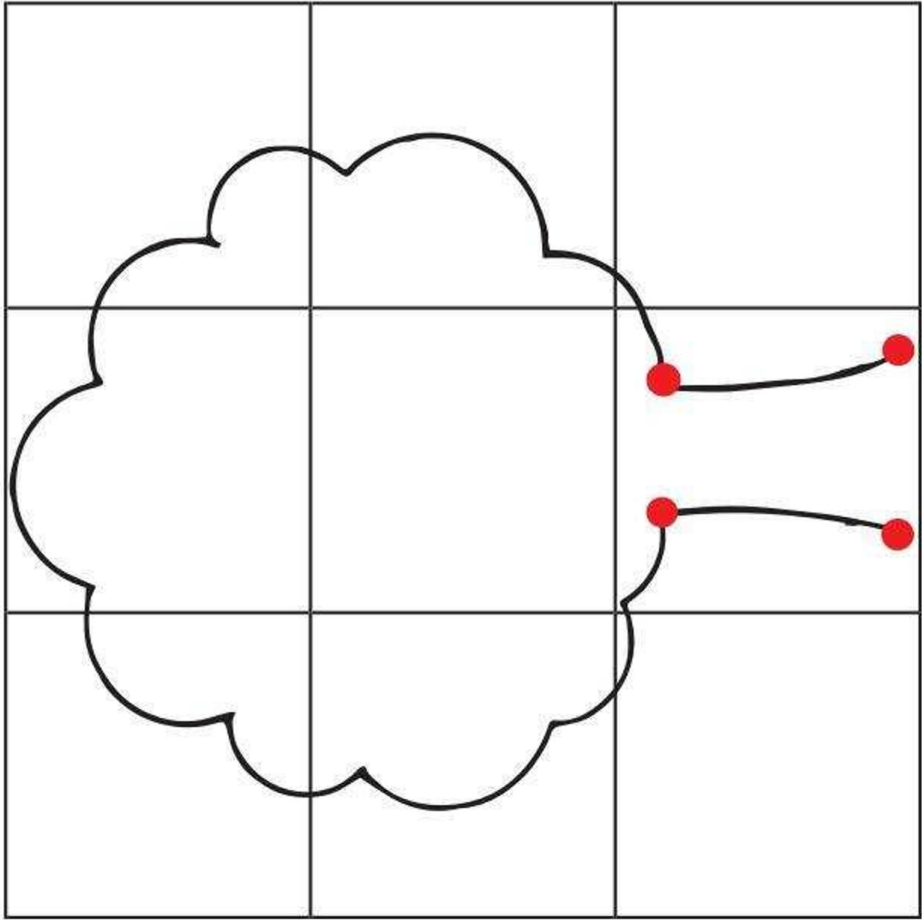

Correspondencias



Une con una flecha cada elemento con la parte del cuerpo que el corresponde.

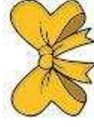
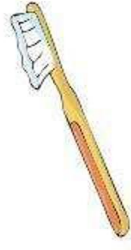
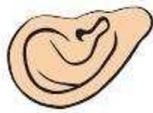
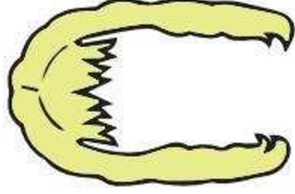
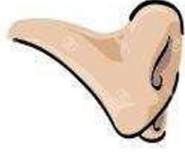
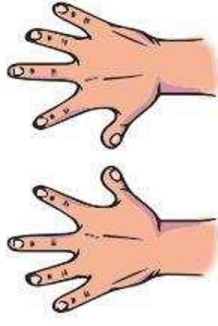

Secuencia por tamaño



Recorta por la líneas y pega de pequeño a grande en la siguiente hoja.

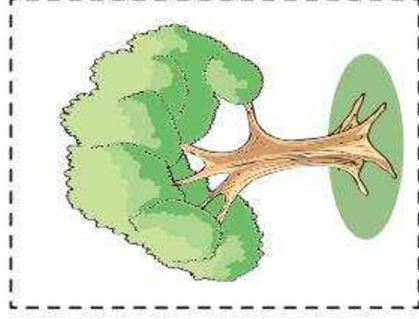
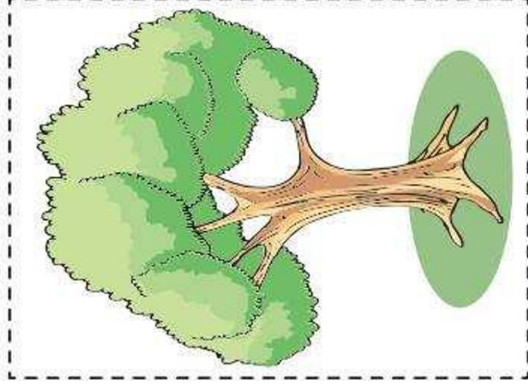
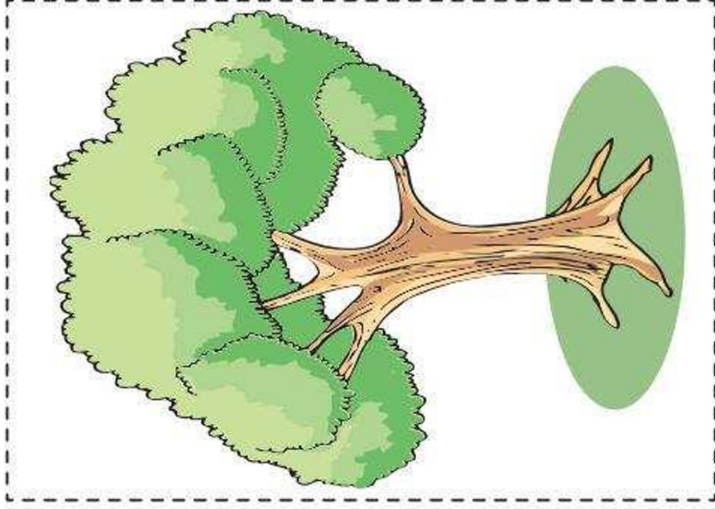
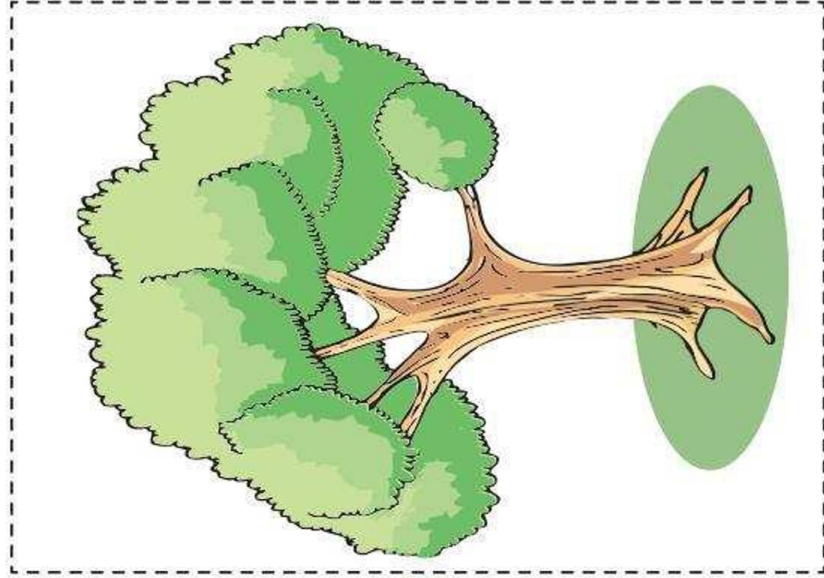



Pega aqui:

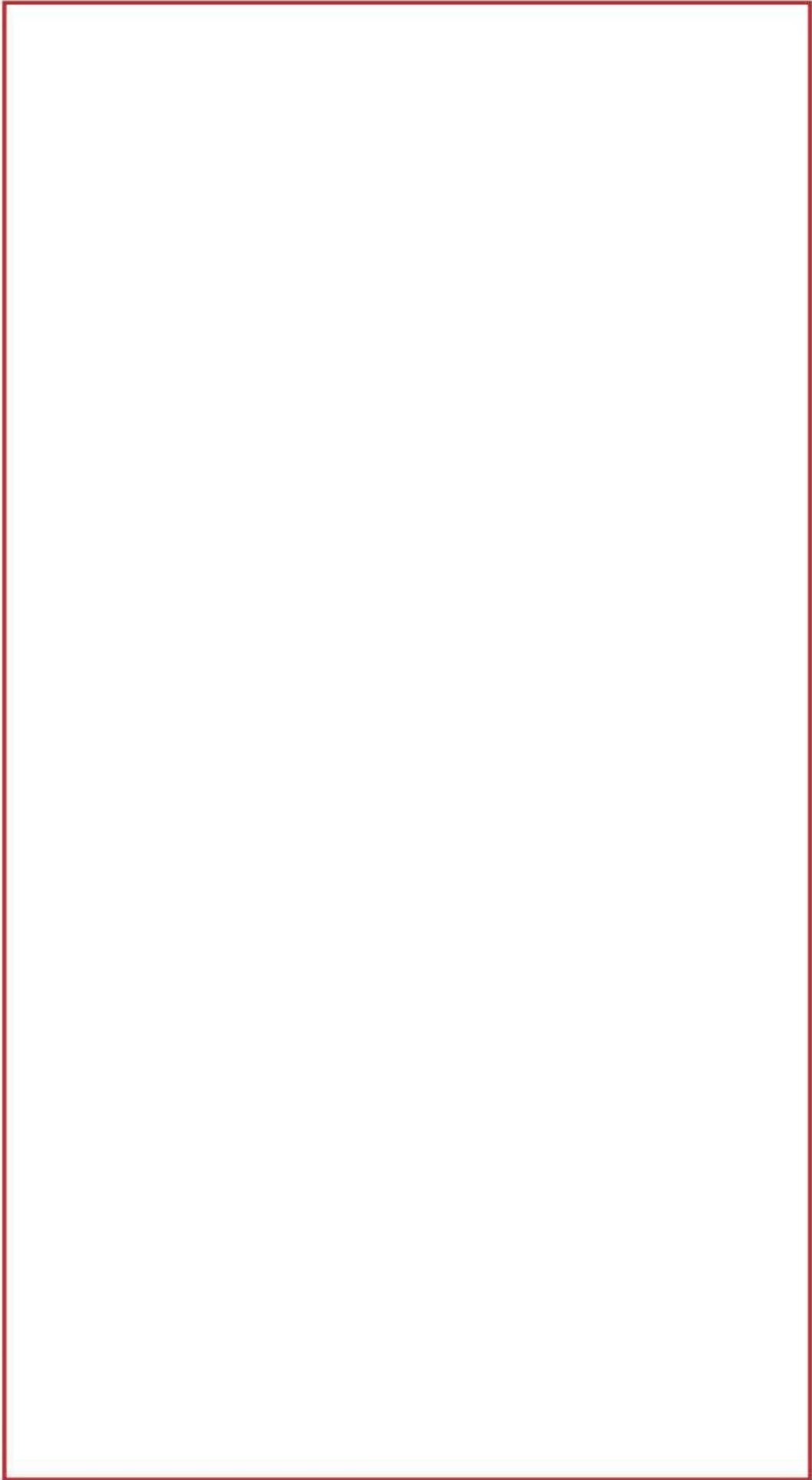

Color Morado

Pega bolitas de papel en la uva.

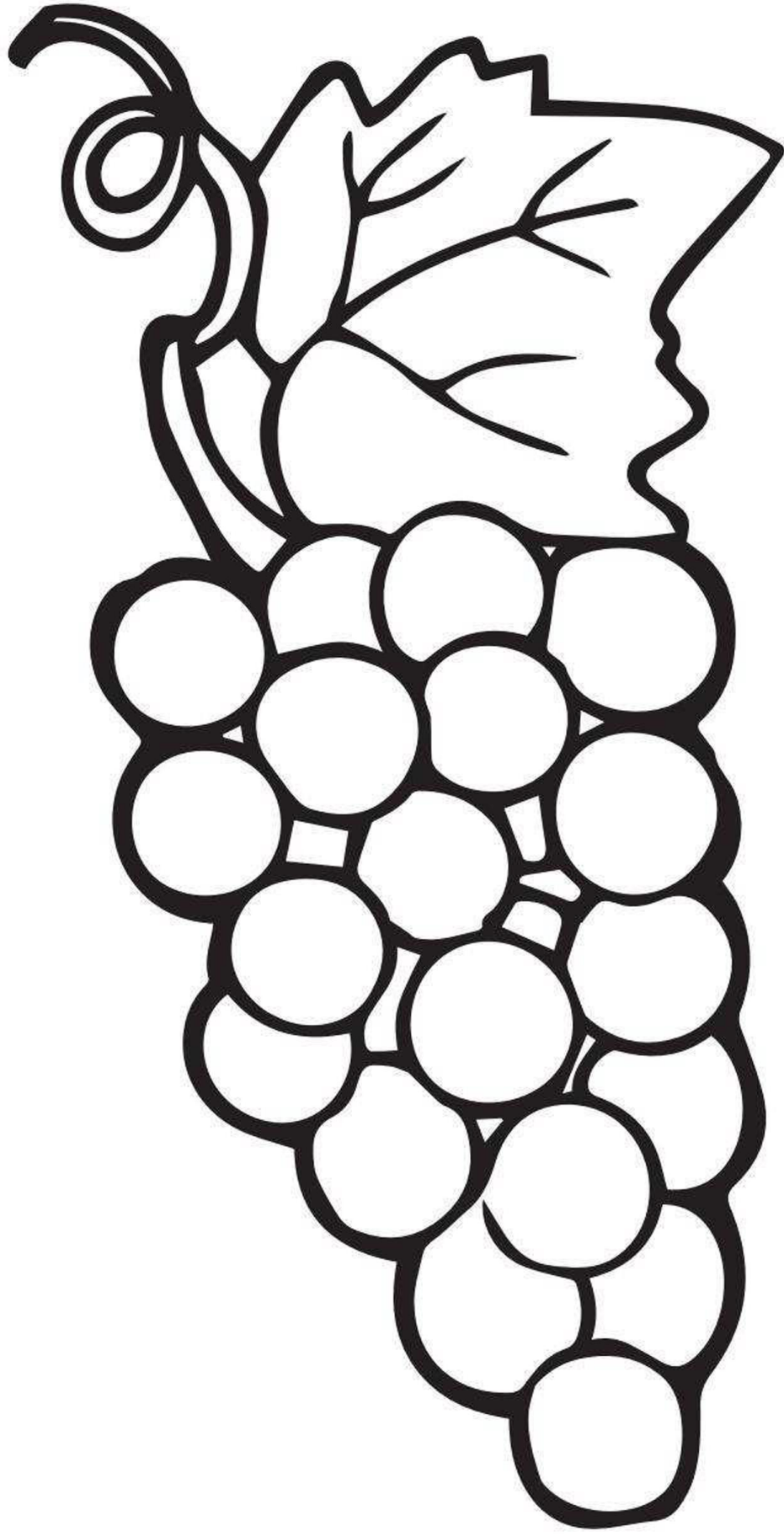

Conjuntos

Agrupar a los patitos de dos en dos.

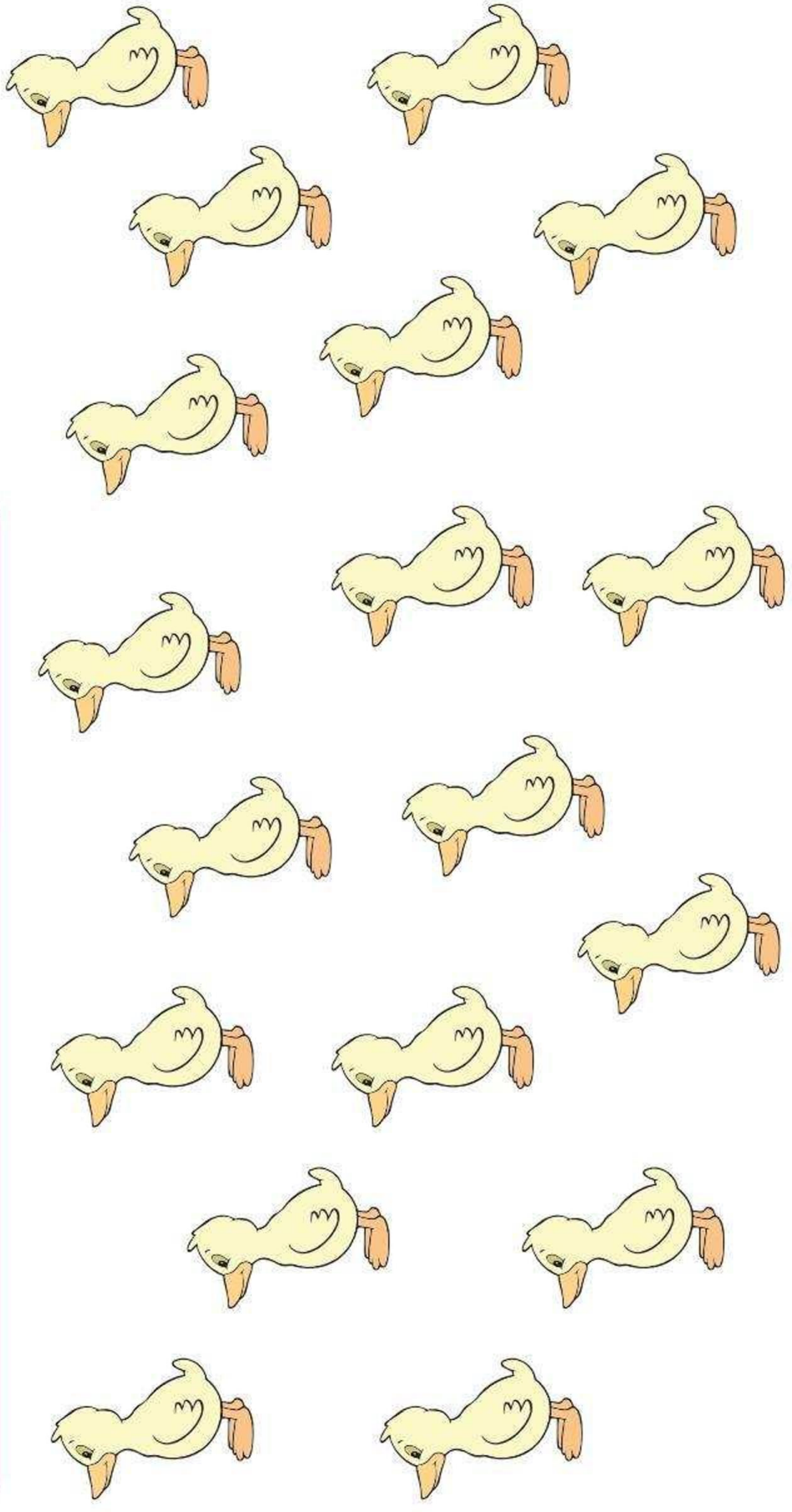

Figuras iguales



Rodea los dibujos que sean iguales a los de la imagen seleccionada.



Secuencia de colores



Colorea la serie teniendo en cuenta el código.

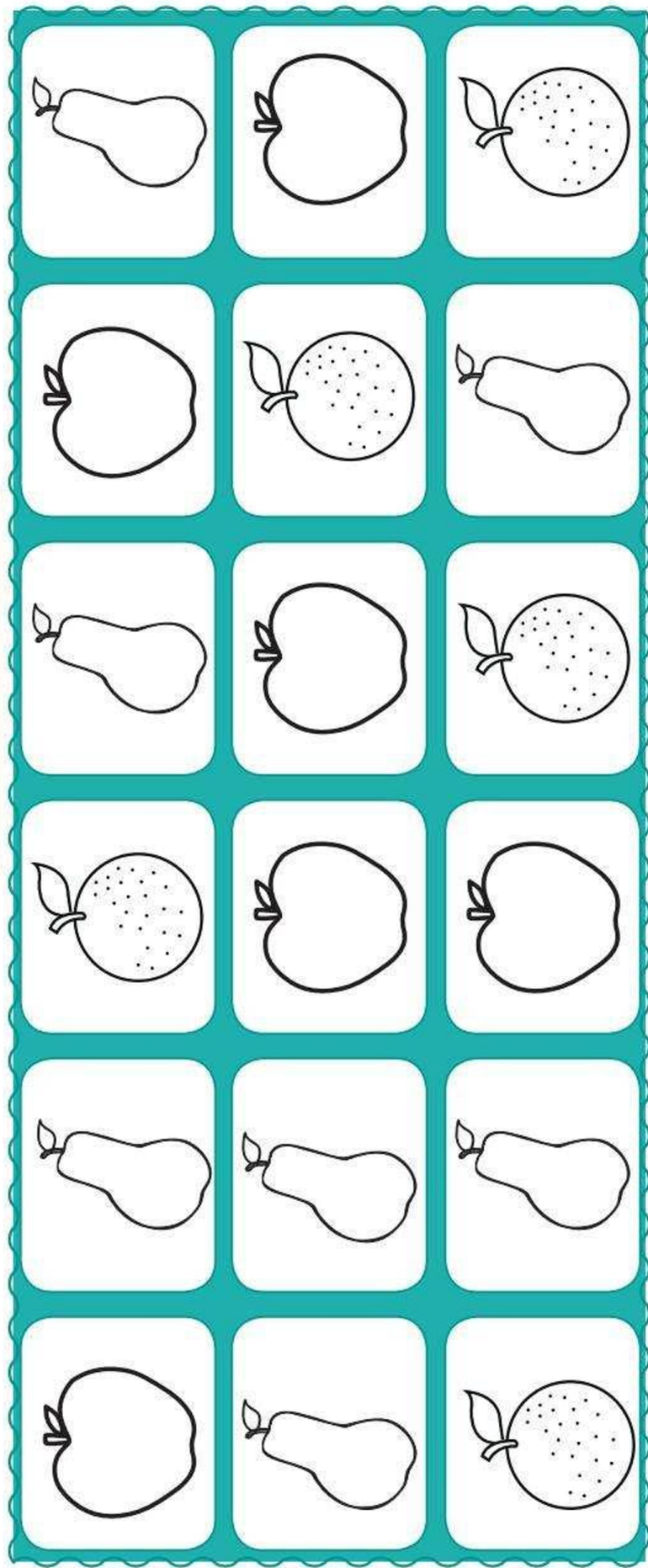
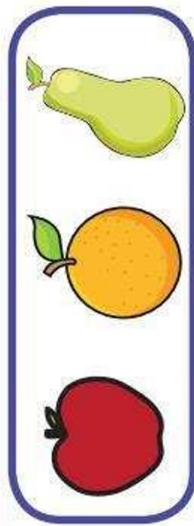

Noción - más o menos

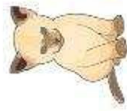

Rodea y pinta el grupo que tiene MÁS.

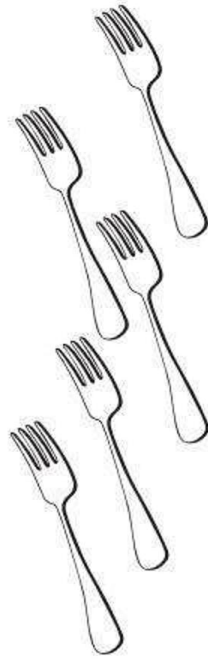
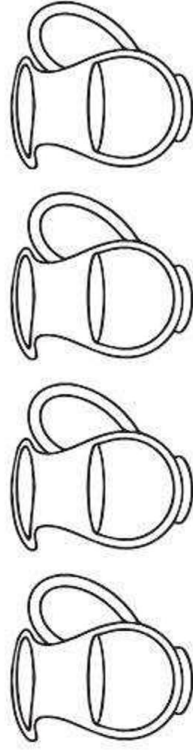
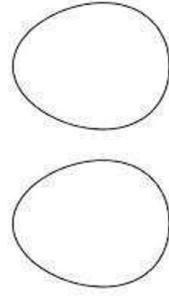
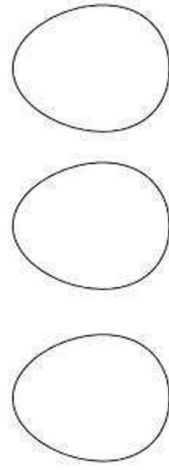
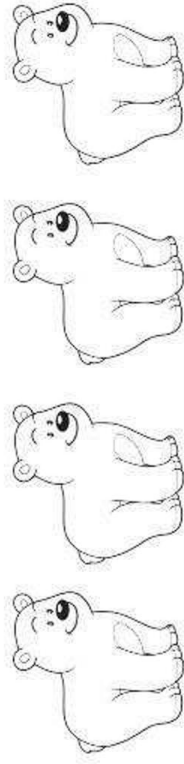

Figuras incompletas



Que le falta a cada uno de los dos dibujos y complétalos.

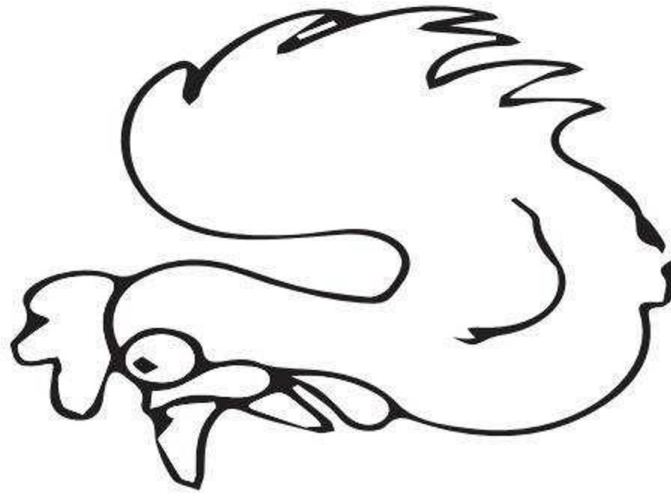
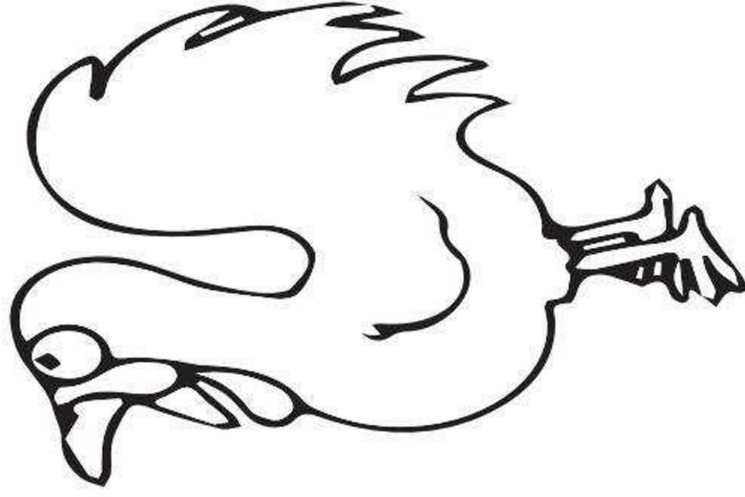
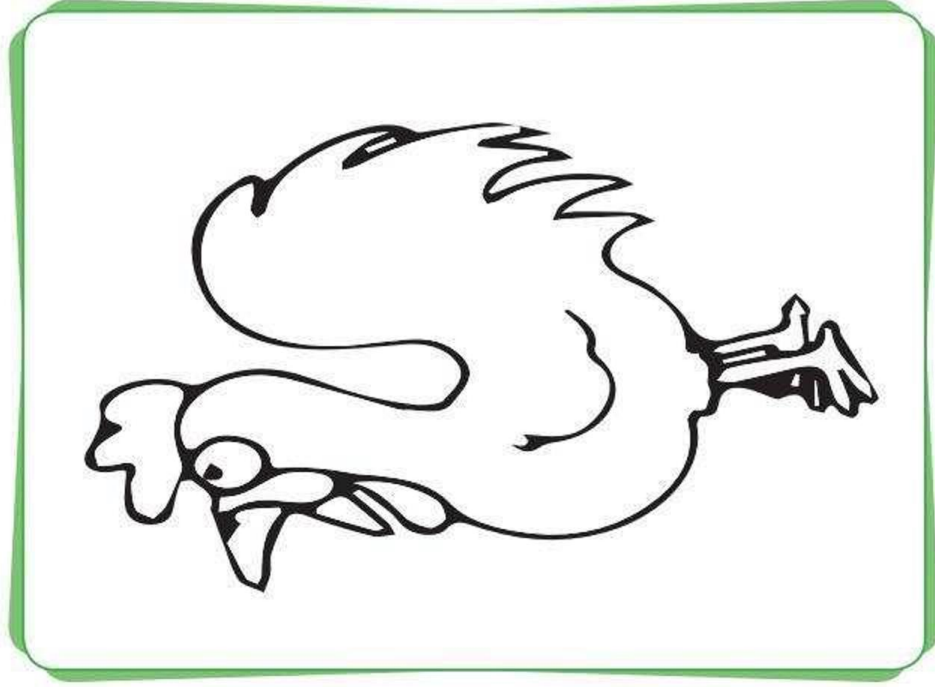



BANCO DE MATERIALES GRATIS
INGRESAR A NUESTRA WEB:



www.manualidadeseducativas.com



Manualidades Educativas

ME Manualidades Educativas



<https://www.facebook.com/MEmanualidadeseducativas>



Material Educativo



<https://www.facebook.com/MEmaterialeducativope>